

Ninestar

Stock Code: 002180.SZ

2023

Ninestar Corporation

**Environmental, Social
and Governance Report**





CONTENTS

1

About the Report	01
-------------------------	----

2

President's Statement	03
------------------------------	----

3

About Ninestar	
3.1 Company Profile	05
3.2 Our Industrial Layout	06
3.3 Company Culture	07
3.4 Core Values	07
3.5 Highlights in 2023	07

4

Implementing ESG Management	
4.1 ESG Management Philosophy	13
4.2 ESG Management Policies	14
4.3 Sustainable Development Commitment	15
4.4 Enhancing the ESG Governance Structure	17
4.5 ESG Management Practices	19
4.6 Integrating Key ESG Issues into Day-to-day Operational Management	19
4.7 Extensive Training to Empower Employee Development	20
4.8 Enhancing Communication with ESG Stakeholders	21

5

Materiality Assessment	
5.1 Reflections on Dual Materiality Assessment	23
5.2 Assessment of Materiality Topics	23

6

Governance	
6.1 Corporate governance	27
6.2 Risk control	34
6.3 Business ethics and anti-corruption	39

7

Social	
7.1 Responsible Supply Chain Management	47
7.2 Employees' rights, interests, diversity and equity	57
7.3 Human Capital Development	69
7.4 Product responsibility	82
7.5 Privacy protection and information security	98
7.6 Occupational health and safety	102
7.7 Community philanthropy	106

8

Environmental	
8.1 Green products	111
8.2 Electronic waste recycling	123
8.3 Energy management	128
8.4 Waste management	133
8.5 Water resources management	135
8.6 Response to climate change	138

9

Appendix	
9.1 Appendix I Key Performance Indexes (KPIs) of 2023 ESG Report	143
9.2 Appendix II Content Index of Global Reporting Initiative (GRI) Standards	145
9.3 Appendix III Feedback Form	149

1. About the Report

The Report is the third Environmental, Social and Governance (ESG) Report (hereinafter referred to as "ESG Report" or "the Report") released by Ninestar Corporation (hereinafter referred to as "Ninestar", "We" or "the Company"). It mainly discloses our ESG management philosophy, management policies, improvement actions, and other achievements in 2023.

References and Basis of Preparation

- Self-Regulatory Guidelines No. 17 for Companies Listed on Shenzhen Stock Exchange—Sustainability Report For Trial Implementation
- GRI Standards of the Global Sustainable Development Standards Board
- Shenzhen Stock Exchange's Social Responsibilities Guide for Listed Companies issued by the Shenzhen Stock Exchange
- Guidance on Implementing the Recommendations of the Task Force on Climate-related Financial Disclosures

Reporting Principles

- 

Materiality

We have engaged a professional third-party institution to identify current ESG material issues based on business characteristics, industry analysis, and expert assessment and submitted the results to our Board of Directors (hereinafter referred to as "the Board of Directors") for review, to determine the materiality ranking of the ESG issues, which is used as the basis for ESG report preparation and management enhancement.
- 

Quantitativeness

We have developed a comprehensive and effective ESG governance structure. Under the leadership of the Board of Directors, we have established and continue to improve data collection tools and review mechanisms through the two-tier governance structure of the "ESG Committee - ESG project team". Where applicable, a comparison between data for this year and previous years is disclosed in the Report to better inform shareholders of our ESG management progress.
- 

Equilibrium

The Report presents our ESG performance in an unbiased fashion. In addition to disclosing working achievements, it also discusses the room for improvement and plans for related issues.
- 

Consistency

To the extent reasonably feasible, the quantitative information in the Report is measured and disclosed in a manner consistent with past practices so that shareholders can analyze and assess our achievements in different periods. If the scope of data collection changes, the data is updated, or the method of measurement is altered, corresponding explanations will be noted for report users' reference.

Time Range

The Report is an annual ESG report that covers the period from January 1, 2023, to December 31, 2023 (hereinafter referred to as "this year" or "the Reporting Period"). Some contents are appropriately extended beyond the Reporting Period and need to be read in combination with our 2023 annual report.

Unless otherwise specified, the amounts involved in the Report are denominated in CNY.

Data Source

All the data used in the Report is mainly derived from public data, internal statistics, third-party surveys, administrative documents, and reports and other relevant documents.

Availability of the Report

The Report is prepared in both Chinese and English versions. In case there is any discrepancy between them, the Chinese version shall prevail.

You can view and download the electronic version of the Report on the Shenzhen Stock Exchange (www.szse.cn) and the Company's website (www.ninestargroup.com).

Feedback

Should you have any questions or feedback on the Report and contents hereof, please contact us by:

Address: No.3883, Zhuhai Avenue, Xiangzhou District, Zhuhai City

Tel: +86(0)756-6258000

Fax: +86(0)756-8539856

Email: info@ggimage.com

ZIP code: 519075

2. President's Statement

To all stakeholders:

The year 2023 brought a mix of opportunities and challenges. All sectors of society have paid increasing attention to the sustainable development of enterprises. From international reporting standards to the regulatory requirements of exchanges and the investment focal points of investors, a growing number of stakeholders have realized that the evaluation of enterprises should not only focus on financial and operating data but also include sustainable development capability and performance in order to understand and perceive the long-term development capabilities of enterprises from a more comprehensive perspective. As an enterprise listed on the main board of the Shenzhen Stock Exchange, we work to propel independent innovation and low-carbon transition with dedication to cultivating our product R&D and operational management capabilities, striving to create responsible products and services and practice high-quality development.

Adhere to ingenious quality, embracing quality development.

We always uphold craftsmanship, encourage independent innovation, pursue excellent quality, and are devoted to becoming "the eminent high-tech service provider in the printer industry". In 2023, we successfully launched a number of high-quality products with independent intellectual property rights. Pantum's first independently researched and developed A3 black-white and colorful copiers provide users with more reliable, highly stable, easy-to-maintain, and low-cost product options. This is also a manifestation

of our adherence to "being steered by user demand, driven by technological innovation and pushed forward by management optimization". We also hope to enhance production efficiency and product quality through digital and intelligent transformation so that more value will be brought to users and more changes to the industry.

Pursue green and clean practices, paving the way for low-carbon development.

In our active efforts to implement and respond to the national "3060" strategy¹, we always strive for green low-carbon development. In 2023, we proposed that our overall carbon emissions should be reduced by 50% by 2030 and, on the basis of this goal, impelled green product production, and green operational management. We also engaged in product lifecycle management in 2023. We paid attention to the integration of clean technology in all phases, such as product design, packaging, and electronic waste recycling, and worked toward the carbon footprint certification of products with systematic steps to reduce the environmental impact of the product lifecycle and manufacture eco-friendly and green products. Since 2018, we have installed photovoltaic power generation equipment on factory rooftops as we increase the applications of clean energy and deepening our green operational management capabilities. We believe that it will help us increase development resilience and enhance market competitiveness if we promote a green and clean production model, dedicate ourselves to green product production, and optimize green operational management.

Harbor a sense of responsibility, building a foundation for high-quality development.

We adhere to the principle of high-quality, sustainable development. We have integrated ESG management standards into our corporate strategy in an orderly manner, and we are committed to consolidating the foundation of development responsibly and acting as responsible corporate citizens. In 2023, driven by our ESG governance structure, we rationally developed enhancement plans through gap identification, surrounding the dual ESG goals of "enhancing internal management and external evaluation", and made steady progress in developing normalized ESG management.

We firmly believe that employees are the cornerstone of our sustainable development and that each employee's unique value and contributions are the key to our success. We are committed to creating a fair and inclusive working environment, listening to the real voices of employees at all levels, and respecting and protecting every employee's desires and choices. We value employees' personal growth and occupational development planning. By establishing a comprehensive training system and an unimpeded growth path, we provide employees with support and incentives to help them improve their job competencies and professional skills.

We are well aware that as a responsible enterprise, we need to comprehensively consider the unity between economic

value and social value. Since our foundation, we have been fulfilling our social responsibilities proactively and continually. We have supported education and participated in community construction in different forms, giving back to society in sincere and practical ways.

If we do not fail Nature, Nature shall never fail us. Looking to the future, we will hold fast to our original aspirations for development, take user demand as a guide, and base ourselves on long-term planning, moving forward steadily as we actively embrace changes to explore a path of high-quality, sustainable development for enterprises. We will develop more improvement action plans and organize their implementation, steadily promote product and service innovation, practice sustainable development principles with concrete actions, and move toward higher management maturity.

Ninestar Corporation

President Kong Dezhu



¹The national "3060" strategy strives to achieve carbon peak before 2030 and carbon neutrality before 2060.

3. About Ninestar

3.1 Company Profile

Founded in 2000, Ninestar Corporation has been ranked among the top 500 listed companies in China for three consecutive years. Focusing on the printing and imaging industry for 23 years, the Company has become the world's fourth-largest laser printer manufacturer and an excellent integrated circuit design enterprise in the industry. In FY2023, the Company's revenue was CNY24.062 billion. We have achieved full coverage of the printing industry chain, with a presence in more than 150 countries and regions around the world, owning several renowned brands in many industries, such as "Pantum (奔图)", "Geehy (极海微)", "Apexmic (艾派克)", "G&G(格之格)", "Static Control (史丹迪)", "Lexmark International (利盟国际)" (hereinafter referred to as "Lexmark"), among others.

We have nine R&D centers in the world, a national-level postdoctoral research workstation, the industry's first state key laboratory of fine chemicals (Zhuhai R&D Center), and the industry's first CNAS-accredited laboratory. Additionally, we own 17 national-, provincial- or municipal-level innovation platforms as well as 30 industry-university-research cooperation platforms and independent innovation platforms. We hope that we will lead business development with technology and create new value through technological innovation and patent development.

During the Reporting Period, we had more than 20,000 employees worldwide, 22.10% of whom were R&D staff. The R&D investments were CNY1.751 billion. Our technological products include laser printers and original supporting consumables, printer master chips, printing consumables chips, printer core components, general micro control units (hereinafter referred to as "MCU"), and compatible supplies, among others. We own 5,862 independent R&D patents all over the world, of which 3,500 are invention patents. We have been awarded the title of National Intellectual Property Advantage Enterprise.

For more information about the Company's business operation and financial condition, please refer to Ninestar's 2023 Annual Report: <https://www.ninestargroup.com/investor-ar.html>

A presence in more than **150** countries and regions around the world

9 R&D centers across the world

Over **21,997** employees worldwide

22.10% R&D personnel account for

3.2 Our Industrial Layout

Printer business

PANTUM 奔图
Lexmark™

Chip business

Geehy SEMICONDUCTOR
APEXMIC

Compatible supply business

G&G Your Image Matters
Static Control www.scc-inc.com
SMART MATE Your Smart Choice & Reliable Mate
格之格 科技让打印更健康
G&G SELECT

3.3 Company Culture

We uphold the corporate mission to fulfill our social responsibilities, to provide exceptional service for our customers, to help realize the dreams of our employees, to create value for our shareholders. With the aspiration to serve the country with industrial development, our founders established the Company, and they believe that "only when the Company adheres to a strong sense of responsibility and mission for the country and the nation will it achieve broad and robust success and create a great brand". To this end, we devote ourselves to facilitating the unity between business value and social value.

Our vision is "To become the eminent high-tech service provider in the printer industry. To build a globally renowned trusted brand". The Company upholds its core values of "loyalty, truth-seeking, innovation and being win-win". As its business expanded from compatible consumables and printers to integrated circuit chips and beyond, Ninestar has grown into a unique, dynamic, and innovative technology services company.

3.4 Core Values

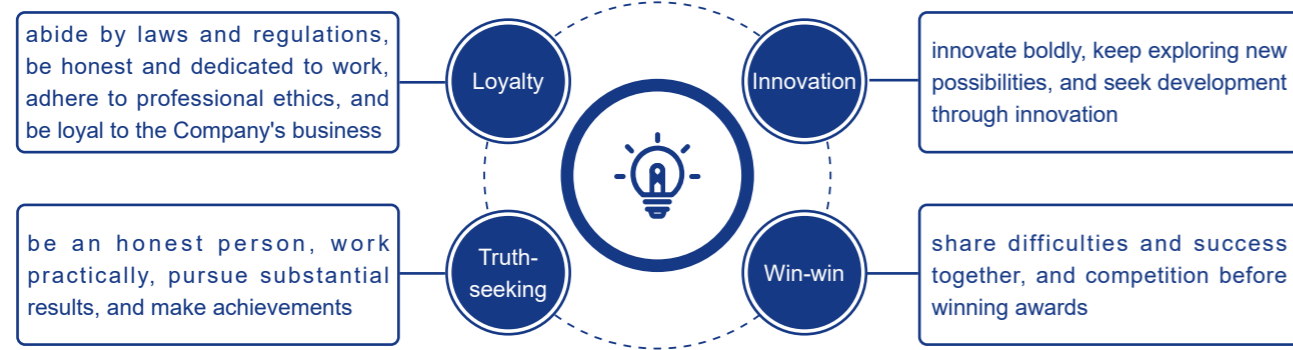

3.5 Highlights in 2023

3.5.1 ESG management enhancement actions

Governance

Develop an effective governance structure

- In December 2022, we set up the Environmental, Social, and Governance (ESG) Committee consisting of directors, with the Director of our Board of Directors serving as the Director of the Committee.
- In April 2023, we established the Integrity and Self-discipline Committee as an independent supervisory organ to enhance our management capabilities in integrity and self-discipline, business ethics, and other dimensions.
- In September 2023, we adjusted the members of our ESG project team and clarified their management duties, making the operation of the ESG project team more reasonable and efficient.

Increase information transparency

- We have improved our information disclosure of sustainable development (<https://www.ninestargroup.com/esg.html>) by designing an ESG information disclosure column on our Chinese and English websites to fully disclose our management systems for sustainable development and related information from the environmental, social, and governance dimensions.

Social

Strengthen supply chain risk management

- We have updated the whole process of hierarchical supply chain management, supply chain access, regular assessment standards, and regular supply chain scorecards.
- In 2023, we conducted audits and surveys on 705 suppliers, covering ESG labor management and conflict minerals management, and implemented CMRT audits of 418 suppliers.
- We have developed a gradually perfected plan for our future conflict minerals management.

Provide responsible products and services

- We have improved the quality management processes and created the quality culture of "Do It Right the First Time".
- We have doubled our efforts in product R&D. Our products have passed a number of international security certifications. During the Reporting Period, we rolled out new products and technologies, such as brand-new A3 copiers and high-performance MCUs for motor control, which have earned recognition from the market.
- We have taken actions to combat counterfeit and shoddy products and also introduced policies and measures to protect consumers' rights and interests.
- Our chip products have won the China Chip "Best Market Performance Award" presented by the Ministry of Industry and Information Technology of the People's Republic of China (MIIT) for eight consecutive years.

Environmental

Actively respond to emerging risks

- According to the recommendations of the Guidance on Implementing the Recommendations of the Task Force on Climate-related Financial Disclosures, we have developed corresponding response measures on the basis of our identification and analysis of climate-related risks and opportunities.

Clean technology applications

- Based on the management philosophy of product lifecycle management covering "green materials - green R&D - green production - green recycling", we keep raising investment in clean technology R&D and optimize green product design at the technological level.
- By strictly observing domestic and international standards for green products, we have obtained corresponding product certifications. We have also adopted environmentally friendly raw materials and innovated new green packaging to reduce the carbon footprints of our products.
- We conscientiously select high-quality raw materials, study components' service lives and optimize design to improve product durability and ease of repair.

Electronic waste recycling

- We have improved the electronic waste recycling process and promoted product recycling actions to cover different countries and regions.
- We have established cooperation relationships with local recycling networks around the world and expanded our global market shares and facilitated the layout of the entire industry chain through strategic cooperation.
- We conduct audits of recyclers. The qualifications of our recyclers and garbage disposal agencies are reviewed based on a strict partner screening mechanism to ensure that they have relevant business licenses and reliable disposal equipment.

3.5.2 Achievements in 2023

• Operating revenue (CNY1 billion)

24.062



• Taxes paid (CNY1 billion)

0.936



• R&D investments (CNY1 billion)

1.751



• Intellectual property rights (item)

5,862



3.5.4 Environmental indicators

• Greenhouse gas (GHG) emission intensity (tCO₂e/CNY10,000 revenue)

0.0108



• Total GHG emissions (including Scope 1 and Scope 2) (tCO₂e)

25,986.26



• Overall energy consumption intensity (tce/CNY10,000 revenue)

0.0025



• Overall energy consumption (tce)

5,935.34

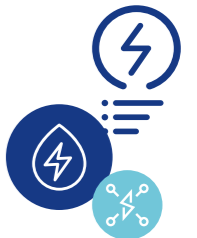

• Total water usage (ton)

1,039,532.69



3.5.3 Social indicators

• Total number of employees

21,997



• Total number of employees trained

8,206



• Total investment in employee training (million)

3.84



• Investment in social assistance (million)

1.33



• Total employee training duration (hours)

165,533.5



• Total duration of occupational health and safety training (hours)

35,638



3.5.5 External recognition

During the Reporting Period, our ESG management performance was recognized by a number of rating agencies and authoritative awards.

Financial indexes

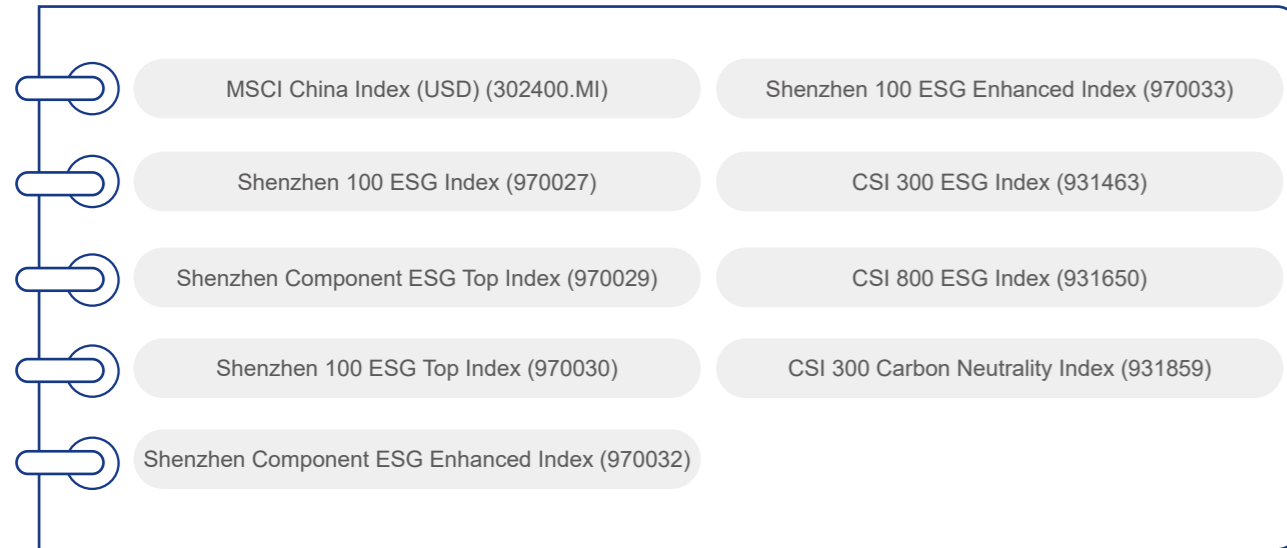

Ratings

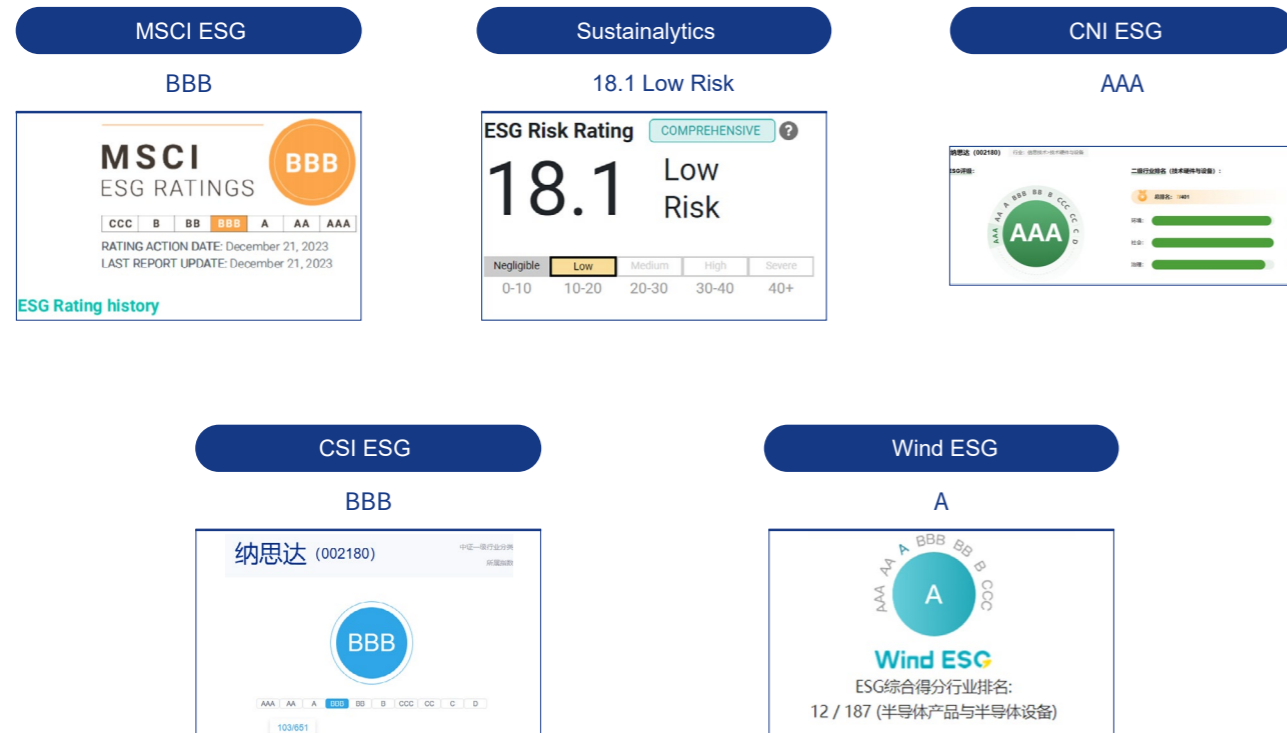

Awards



4. Implementing ESG Management

In alignment with the United Nations Sustainable Development Goals (SDGs)², guided by the scientific objectives³ and China's carbon reduction targets and action plans⁴ for the 14th Five-Year Plan period, we adhere to the principle of high-quality, sustainable development. We have integrated ESG management standards into our corporate strategy in an orderly manner, committing to operate responsibly. Our goal is to create a range of sustainable environmental, social, and economic benefits across dimensions such as environmental protection, clean technology applications, product quality, employee responsibility, supply chain construction, and community welfare. We strive to continuously enhance our capacity for sustainable development and to act as a responsible corporate citizen.



4.1 ESG Management Philosophy

We have established an ESG Committee and have clearly defined the Board of Directors' Environmental, Social, and Governance (ESG) Committee Rules of Procedure. We adhere to a Plan-Do-Check-Act (PDCA) cycle to continuously review our sustainable development performance and strengthen ESG management across all aspects. Our efforts are aimed at generating greater economic, environmental, and social benefits for our stakeholders. We engage in regular stakeholder communications, benchmark analyses with industry peers, set development goals, and



² United Nations Sustainable Development Goals (SDGs) refers to the 17 global development goals set by the United Nations.
³ The Paris Agreement is committed to achieving a global average temperature rise of 2 degrees Celsius below pre-industrial levels and to working towards limiting it to 1.5 degrees Celsius.
⁴ The 2025 and 2030 targets and action plans mentioned in China's Action Plan for Carbon Dioxide Peaking Before 2030.

4.2 ESG Management Policies

To effectively advance the management of key ESG topics, we have extensively referenced domestic and international sustainable development guidelines and standards to formulate the Ninestar ESG Management Policies from multiple dimensions. We continuously revise and optimize our ESG management strategies, standardizing and guiding our high-quality, sustainable development management.

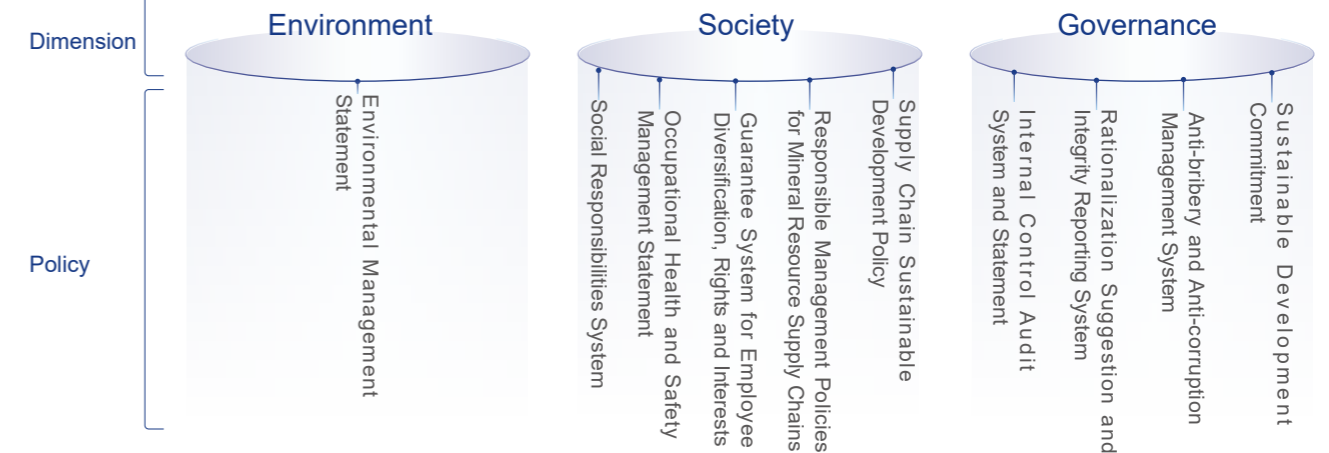

propose improvements. By incorporating sustainable development principles into every aspect of our business operations, we also enhance transparency by publishing annual ESG reports. These efforts actively address the concerns of stakeholders and comprehensively showcase our annual sustainable development performance.

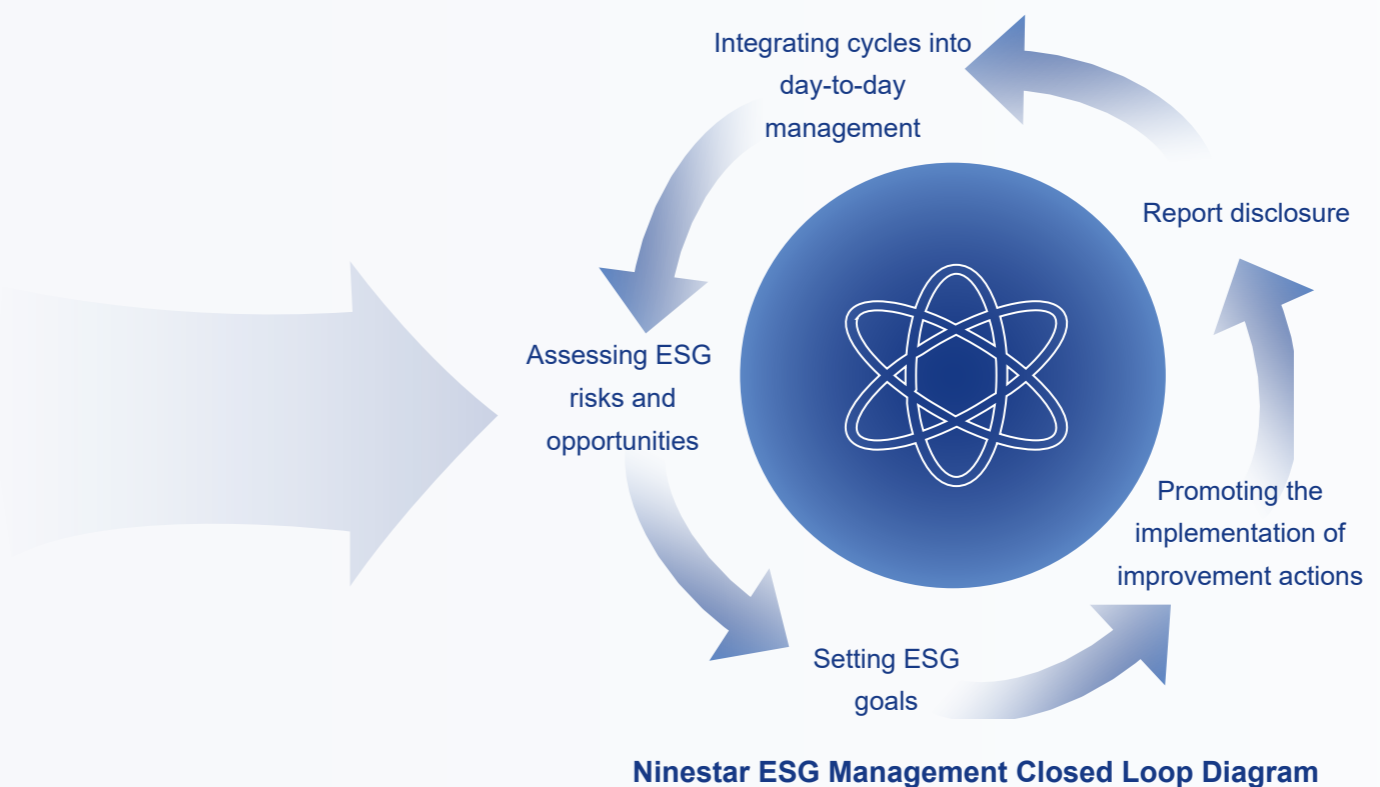

4.3 Sustainable Development Commitment

We commit to fully integrating sustainable development principles into all aspects of our business operations while providing innovative products and services. We are dedicated to building a sustainable development management system, adhering to ethical and compliant business practices, continuously enhancing communication with stakeholders, ensuring the Company's high-quality, sustainable development, and creating long-term value.

Details of undertaking

We maintain a customer-centric approach, creating maximum value with superior products and services, and pursuing mutually win-win cooperation.



We actively foster a fair, open, transparent, and sustainable supply chain, working together with suppliers to make sustainable development a key component of our procurement strategy.



We are committed to addressing global climate change, producing top-tier green products, and ensuring that R&D, design, procurement, production, logistics, and recycling processes meet the requirements for environmental sustainable development, achieving a harmonious cycle between corporate and environmental development.



We actively assume corporate social responsibilities, participate enthusiastically in targeted poverty alleviation and public welfare initiatives, and strive to build better communities.



Details of undertaking

We protect the interests of investors and aim to enhance corporate performance to reward our stakeholders.



We conduct stringent lifecycle quality management of products, adhere to a safety-first principle, and leverage our core technological strengths and sustainable R&D capabilities to provide world-class solutions and services for global new energy applications.



We enhance protections for employee rights, uphold the principle of equal employment, provide comprehensive training and fair development opportunities, offer diverse benefits, and continuously foster a safe, healthy, comfortable, warm, and harmonious work environment.



We consider diversity factors, including gender, age, nationality, cultural and educational background, and professional experience when appointing board members.

We regularly review the effectiveness of Board of Directors diversity.



4.4 Enhancing the ESG Governance Structure

To strengthen our management capabilities in ESG governance, Ninestar has established an ESG governance structure led by the Board of Directors. This structure implements multilevel supervision across all ESG layers, ensuring seamless integration from initial decision-making and communication to final execution.

The Board of Directors, serving as the highest governance body, actively participates in the formulation of ESG strategies, oversees the Company's ESG developmental direction and strategies, and regularly discusses and reviews the risks and opportunities related to ESG development.

The ESG Committee is primarily responsible for setting the Company's sustainable development goals and development plans. It supervises the operation of the sustainable development systems across various business units, providing suggestions and solutions for improving the Company's sustainable development performance. The ESG Committee members come from diverse backgrounds with extensive industry experience, covering areas such as corporate management, financial management, and risk management. This diversity provides various professional perspectives and risk preferences, enabling the Company to better manage complex ESG risks and seize development opportunities.

Furthermore, to ensure the ongoing advancement of our ESG governance, we have established ESG project working groups that include management from the parent company and its subsidiaries. These groups are responsible for coordinating, planning, implementing, and supervising the Company's ESG activities.

Under the leadership of the Board of Directors, the Company has developed a comprehensive and effective ESG governance structure. Through the "ESG Committee - ESG Project Working Group" framework, we fully identify and organize the internal departments responsible for managing critical ESG issues, clearly define their management responsibilities, and specify the requirements and standards for enhancing ESG management planning, thereby thoroughly integrating Ninestar's ESG management philosophy into our business operations.

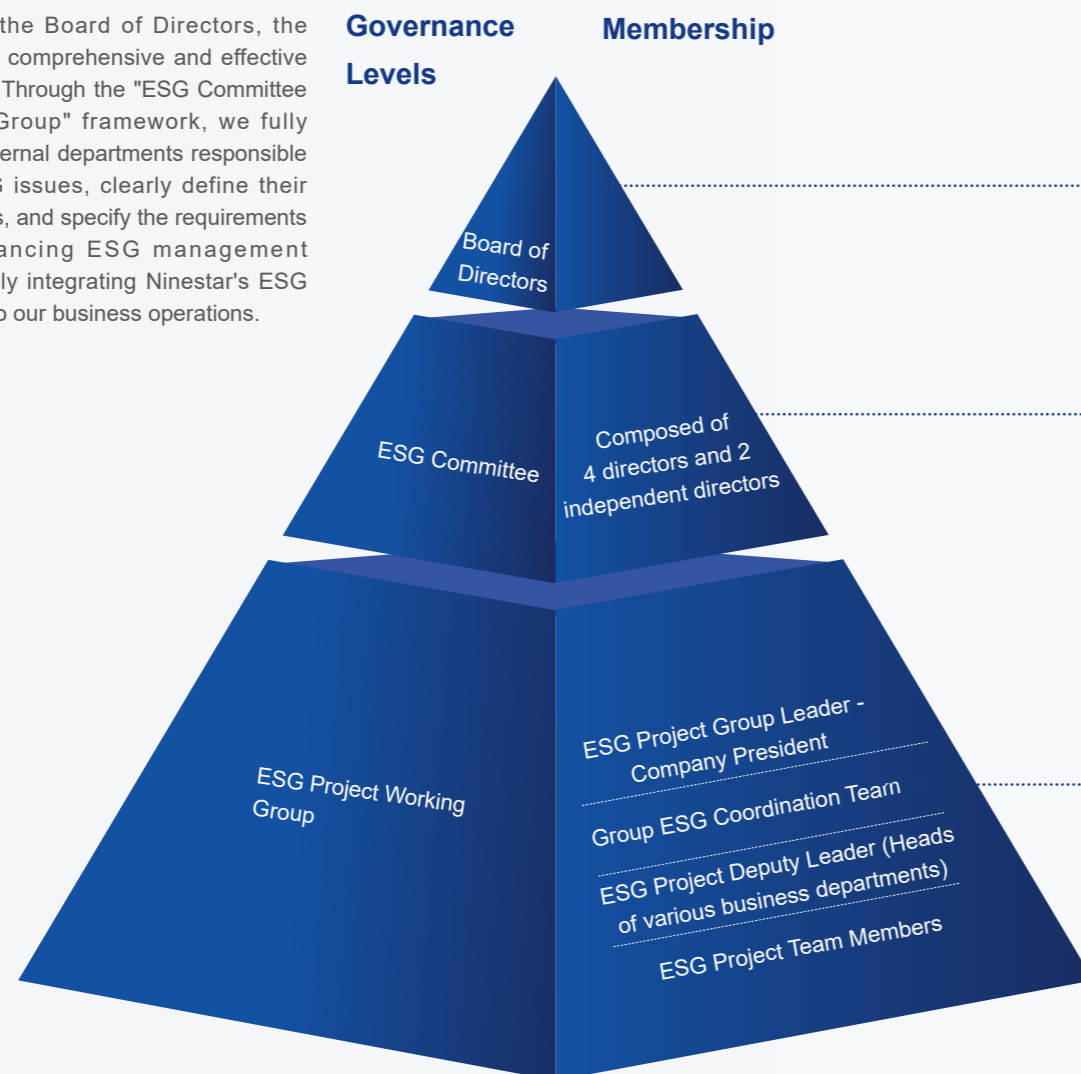

Management Responsibilities

- Coordinate ESG Strategy, Risk Management, and Objective Management
- Develop and implement the Company's ESG strategic planning, management structures, systems, strategies, and detailed rules to ensure continuous execution and implementation of the Company's ESG policies.
- Allocate resources related to ESG work, including human, financial, and natural resources.
- Draft key performance indicators for the Company's ESG, proposing assessments based on the outcomes and performance targets of the Management's sustainable development initiatives.
- Review company disclosures related to ESG, including but not limited to annual ESG reports.
- Pay attention to relevant risks in the ESG domain, proposing counter-strategies.
- Perform inspections on the implementation of the above matters.
- Handle other matters authorized by the Board of Directors.

ESG Project Group Leader - Company President

- Coordinate the preparation of ESG reports.
- Develop the Company's ESG strategic direction.
- Set ESG development goals and supervise their achievement.
- Allocate company resources to support ESG activities.
- Approve institutional documents related to ESG.
- Approve the annual ESG work plan and implementation schemes.
- Regularly report significant ESG-related matters to the Board of Directors.
- Approve other significant matters related to the Company's ESG activities.

ESG Project Deputy Leader (Heads of various business departments)

- Participate in drafting institutional documents related to the ESG management system, clearly defining responsibilities for controlling ESG information flows.
- Develop annual ESG work plans, interim goals, and implementation schemes.
- Arrange ESG liaison personnel and follow up on specialized ESG activities within the Group.
- Supervise the progress of departmental ESG activities.
- Cooperate with the Group Coordination Team to conduct regular internal promotional training.

Group ESG Coordination Team

- Continuously research ESG developments within the industry.
- Stay updated on the latest ESG policies.
- Develop actions to improve the Company's ESG.
- Create ESG policies that align with the Company's developmental interests.
- Coordinate with various departments and subsidiaries to ensure the implementation of improvement actions.
- Provide internal ESG consultancy services to departments and subsidiaries.
- Regularly report on ESG activities to the project group leader.

ESG Project Team Members

- Regularly record, collect, and report ESG-related information.
- Participate in drafting and reviewing ESG reports and promptly respond to questionnaires from rating agencies, implementing ESG improvement action plans and carrying out specialized tasks related to ESG development.
- Regularly track the progress of ESG activities, identify, assess, and report ESG-related risks.
- Organize and implement daily management activities related to ESG research, training, communication, and dissemination.
- Promote ESG-friendly concepts and measures in daily operations.
- Regularly report on ESG work progress to leadership.

4.5 ESG Management Practices

In 2023, under the governance of the Ninestar ESG framework, we methodically advanced normalized ESG management. By organizing ESG working meetings and engaging middle and senior management in ESG enhancement plans, we drove improvements in the Company's overall ESG management and action capabilities.

We adhere to the dual ESG goals of "enhancing internal management and external evaluation". Comprehensive ESG enhancement proposals that consider business operational management needs were developed across all levels and business units of the Company. Through identifying the deficiency of the Company, we formulated short, medium, and long-term enhancement plans, promoting the integration of ESG values with business values and effectively fostering the practice of normalized ESG management.

4.6 Integrating Key ESG Issues into Day-to-day Operational Management

In 2023, we focused on key issues highlighted by external rating agencies as levers for management enhancement, identifying several industry-critical issues related to Ninestar's business, including "clean technology opportunities", "e-emissions management", "human capital development", "controversial procurement", and "supply chain labor management". By aligning management guidelines for these issues with industry best practices and identifying gaps, we developed strategies tailored to the Company's needs.

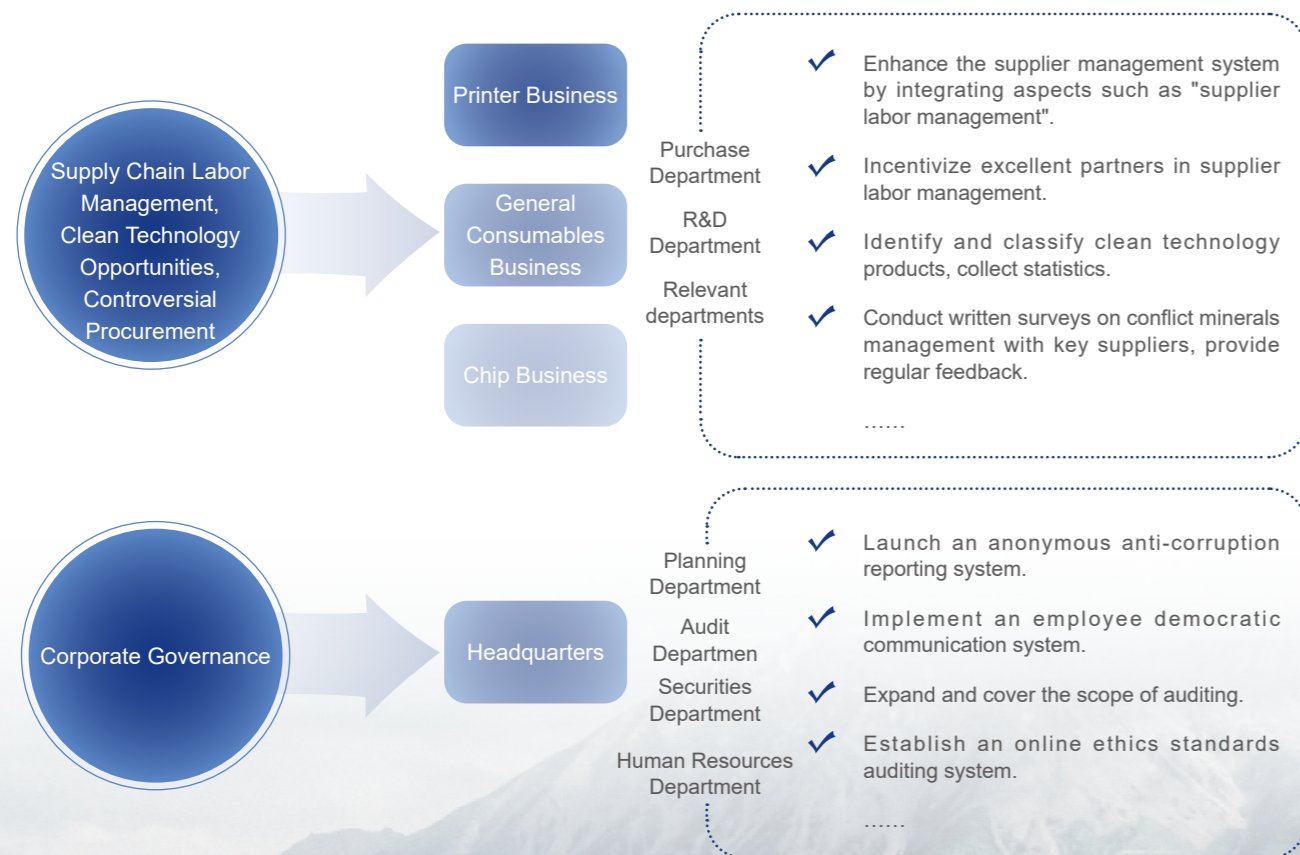

In addressing issues related to supply chain labor management, clean technology opportunities, and contentious procurement, we have advanced management enhancement plans across our printer, consumables, and semiconductor sectors. This involves collaboration with departments such as the R&D Department and the Procurement Department to refine our supplier management systems. This includes integrating "supplier labor management" into our regulatory standards, identifying and recording products related to clean technology, and conducting research on conflict minerals management with key suppliers. Concerning corporate governance, we have collaborated with departments such as the Planning Department, Audit Department, and Human Resources Department to launch systems such as an anonymous anti-corruption reporting system, an employee democratic communication system, and a business ethics auditing system. These initiatives are being progressively implemented to enhance ESG management and fully integrate ESG elements into everyday corporate management.

4.7 Extensive Training to Empower Employee Development

Ninestar places high importance on ESG management. Employees at all levels actively participate in the annual ESG Committee meetings, where they collaborate with committee leaders to discuss and develop ESG strategies that align with our business needs, crafting ESG management enhancement action plans and goals for various business units.



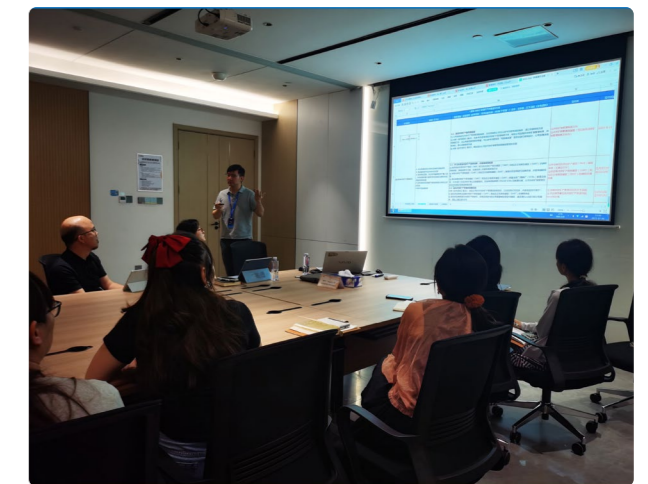





In 2023, we conducted 12 internal ESG training sessions encompassing all major subsidiaries. The training covered various topics, including the latest ESG trends, industry best practices, rating management standards, and company improvement action plans. This ensures the effective implementation and continuous improvement of ESG principles within our day-to-day operations, thereby facilitating the practical application of our ESG management initiatives.



4.8 Enhancing Communication with ESG Stakeholders

The Company has established a dedicated mechanism for external communication on ESG topics, maintaining an active dialog with ESG rating agencies, ESG investment institutions, and leading enterprises regarding ESG trends, management enhancement, and regulatory updates to learn from their experiences and foster our ESG initiatives. During the Reporting Period, we held six external communication meetings focused on ESG themes.

We have developed a diversified communication mechanism, establishing close ties with stakeholders through a combination of online and offline interactions and actively responding to their expectations through communication and cooperation. During the Reporting Period, the Company conducted an in-depth online survey among different stakeholders, receiving 836 responses, with the results outlined below:

Stakeholders	 Government and regulatory authorities	 Investors	 Employees	 Consumers	 Suppliers	 Distributors	 Partners	 Media	 Public
Their concerns	<ul style="list-style-type: none"> Implementation of macro policies Employment promotion Lawful and compliant operation Corporate sustainable development 	<ul style="list-style-type: none"> Continuous value creation Prevention of operation risks Protection of shareholders' rights and interests Good information disclosure Corruption-free business environment 	<ul style="list-style-type: none"> Protection of basic rights and interests of employees Employee care Occupational Health and Safety Employee training and occupational development 	<ul style="list-style-type: none"> Information security and privacy protection High-quality products and services Localized products and services 	<ul style="list-style-type: none"> Open, fair and just procurement Insist on integrity management Long-term and stable cooperation Support the supplier growth 	<ul style="list-style-type: none"> Win-win cooperation High-quality products and services Abide by business ethics 	<ul style="list-style-type: none"> Conduct cooperation Responsible products Product optimization and innovation Business ethics and anti-corruption 	<ul style="list-style-type: none"> Response to public opinions Information publication 	<ul style="list-style-type: none"> Strengthen the communication and exchange Support the public welfare
Our daily communication and responses	<ul style="list-style-type: none"> Strictly abide by the laws and regulations of each place where we operate Conduct integrity management and pay taxes in accordance with the law Participate in the policy and plan research and formulation Accept supervision and assessment Lean management and sustainable development 	<ul style="list-style-type: none"> Comply with relevant laws and regulations Hold general meetings of shareholders Regularly disclose operating and financial information Regular and daily communication with investors Strengthen the compliance and internal control system 	<ul style="list-style-type: none"> Establish a fair and just remuneration system Care about special employees Strengthen the construction of occupational health and safety management system Establish a long-term talent training mechanism Conduct employee satisfaction surveys Provide anonymous channels for collecting reasonable employee demands 	<ul style="list-style-type: none"> Strengthen the information security and privacy protection measures Develop a quality management system, and ensure smooth service networks Keep consumer feedback channels open Conduct the product satisfaction survey and feedback Cultivate the local market, and continue the technological innovation Introduce policies to combat counterfeit and shoddy products in the market 	<ul style="list-style-type: none"> Establish fair and transparent procurement principles and processes Advocate for a sustainable supply chain Carry out ESG management of supply chain Carry out regular communication with and training of suppliers 	<ul style="list-style-type: none"> Expand cooperation and exchange channels Keep product and service feedback channels open Strictly abide by the laws and regulations of each place where we operate Strict review and certification 	<ul style="list-style-type: none"> Strengthen the industry-university-research project cooperation Provide support to teaching in universities Enhance the product innovation consciousness Keep regular or irregular communication 	<ul style="list-style-type: none"> Strengthen the public opinion monitoring Maintain communication with the media 	<ul style="list-style-type: none"> Keep the communication channels open Organize social welfare activities and volunteer activities

5. Materiality Assessment

As the latest domestic and international ESG reporting standards are released, our assessment of materiality topics will comprehensively consider both "financial materiality" and "impact materiality" (dual materiality). We are committed to proactively discussing guidelines for dual substantive assessment of materiality topics in order to strengthen the management of ESG risks and the identification of opportunities.

5.1 Reflections on Dual Materiality Assessment

The Company aims to advance the dual materiality assessment of the fifteen ESG topics under Ninestar's framework, considering both "financial materiality" and "impact materiality". Guided by the GRI3 standards, we identify issues that may either enhance or diminish company value, providing relevant ESG insights for future business strategic decisions.

5.2 Assessment of Materiality Topics

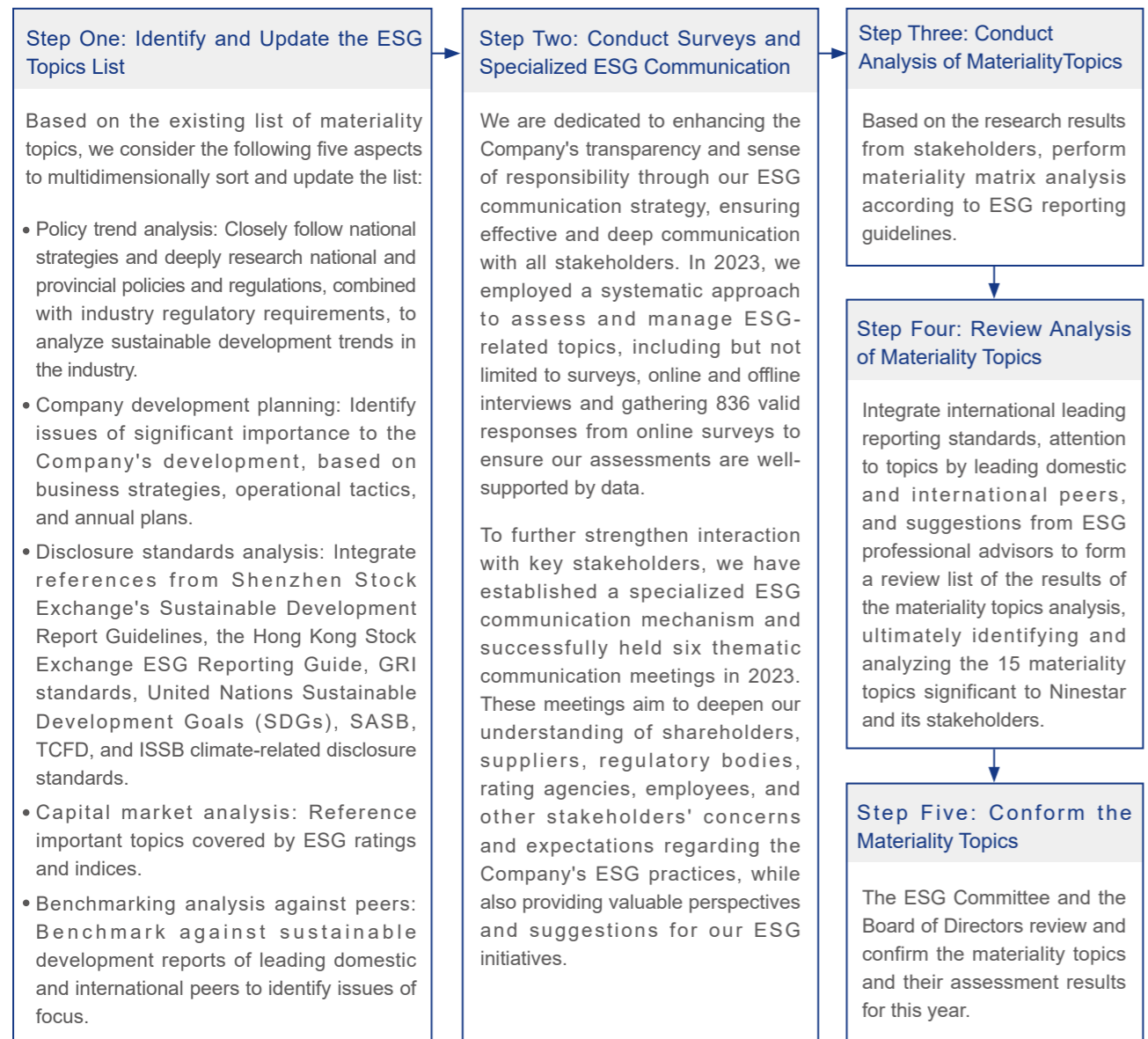

Based on the final review results, green products, clean technology, and electronic waste recycling have been added as highly-priority topics for this year, while employees' rights, interests, diversity and equity, privacy and information security, occupational health and safety, product liability, corporate governance, and risk management remain highly material topics. Additionally, the importance of addressing climate change has increased compared to previous years.

Materiality Topics Matrix and Ranking

Classification	Order	Issue	Dimension	Order	Issue	Dimension
Of high importance	1	Green products	Environment	5	Occupational Health and Safety	Society
	2	E-Waste recycling	Environment	6	Responsible supply chain management	Society
	3	Waste management	Environment	7	Product responsibility	Society
	4	Employees' rights, interests, diversity and equity	Society			
Of medium importance	8	Information security and privacy protection	Society	12	Respond to climate change	Environment
	9	Corporate governance and risk management	Governance	13	Energy management	Environment
	10	Business ethics and anti-corruption	Governance	14	Water resources management	Environment
	11	Human capital development	Society			
	15	Social welfare	Society			
Generally important						

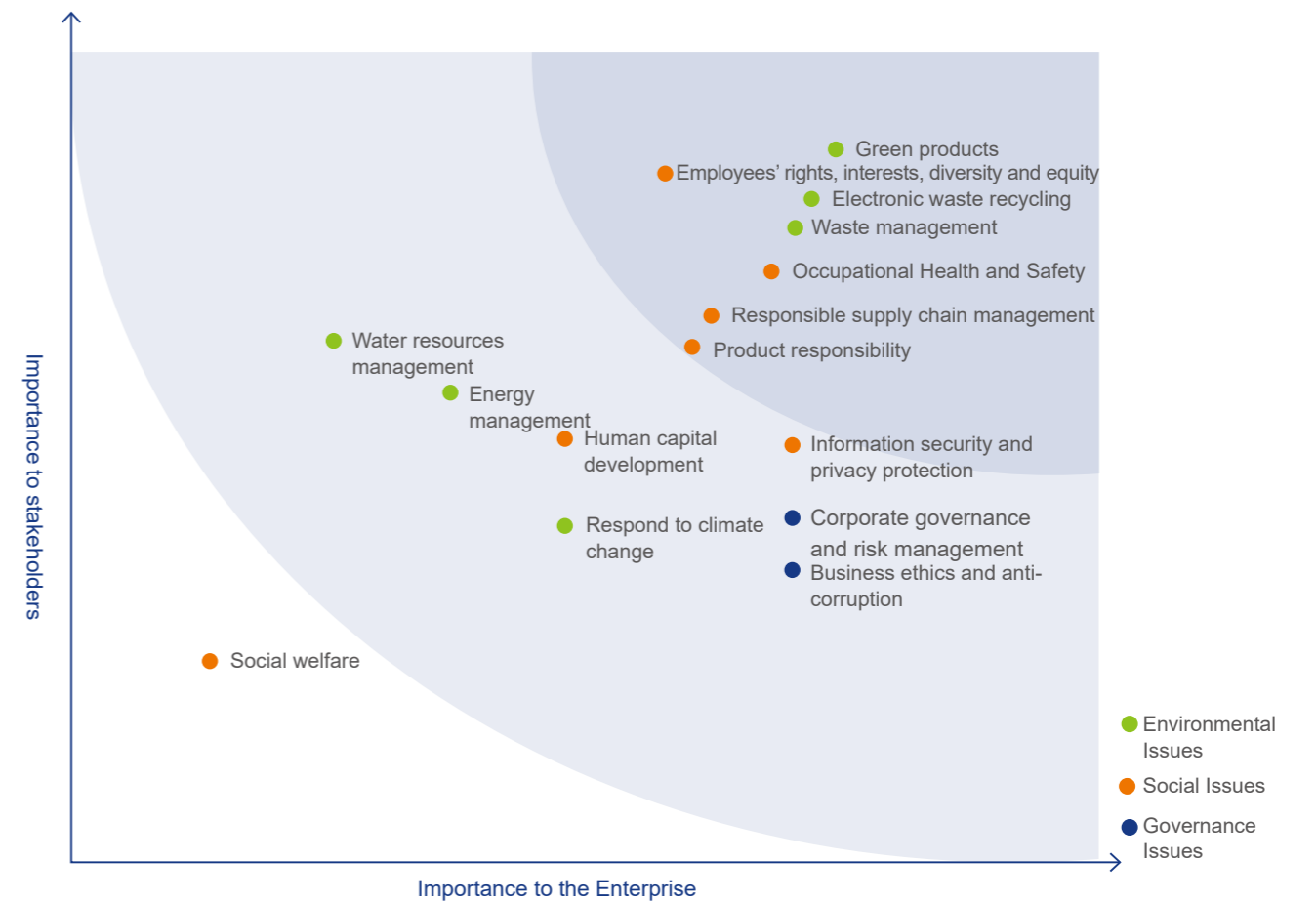



6. Governance

We are committed to creating a business environment based on compliance and good faith. Through continuous improvement of our corporate governance systems, we have established an efficient and reasonable governance structure, strengthened our internal control and risk management abilities, and regulated our operations to improve our risk assistance capability. Meanwhile, we have improved our business ethics practices and adopted an attitude of zero-tolerance towards violations. Emphasizing fair competition, we integrate integrity culture into our routine operations and give play to its positive impact on the industry ecosystem, thereby promoting our quality and stable development.

Material issues	Response to GRI indicators	Chapter Navigation Contents
<ul style="list-style-type: none">• Business ethics and anti-corruption• Corporate governance and risk management	<ul style="list-style-type: none">• GRI 2: 9, 10, 12-14, 16, 22, 29• GRI 205• GRI 206	<ul style="list-style-type: none">6.1 Corporate governance6.2 Risk control6.3 Business ethics and Anti-corruption

Response to SDGs



6.1 Corporate governance

6.1.1 Concept

In the context of globalization and sustainable development, ESG factors play an importance role in measuring corporate governance and ESG risk management. In order to increase our sustainable development capability, we review our performance in ESG and corporate governance and achieve a more transparent and efficient corporate governance structure through benchmarking excellent national and international peers and focusing on the concerns of international authoritative rating agencies, thereby gaining the trust of both investors and stakeholders.

We believe that the optimization of corporate governance means more than compliance with laws and regulations. Instead, we should take the initiative to integrate ESG factors into Company Culture. In 2023, through gradually promoting the ESG concept and cultural publicity training, we boosted the organic integration of the ESG concept by our management at all levels into their routine operations, management, and decision-making and ensure that the corporate strategy complies with high-quality, sustainable development principles, further improving our brand image, market recognition, and market competitiveness.

We are confirmed that our ESG efforts will drive the overall advancement in corporate governance, reduce operation risks, and achieve prudent corporate growth in the long run. Such a responsibility-oriented operation management model can not only protect our cost-effectiveness but also benefit all stakeholders, including employees, customers, suppliers, communities, and the environment. Following this cycle, it empowers corporate development, making us more competitive and attractive in the global market and creating more value for society.

6.1.2 Strategy

A well-established governance structure and clear governance responsibilities serve as the core of promoting effective corporate governance. Our Board of Directors is fully responsible for corporate business operations and strategy development. We have set up five professional committees, namely, the Strategy Committee, Remuneration and Evaluation Committee, Audit Committee, Nomination Committee, and ESG Committee, under the Board of Directors. Each professional committee gives full play to its professionalism and operational efficiency to ensure rational and efficient operation decision-making.

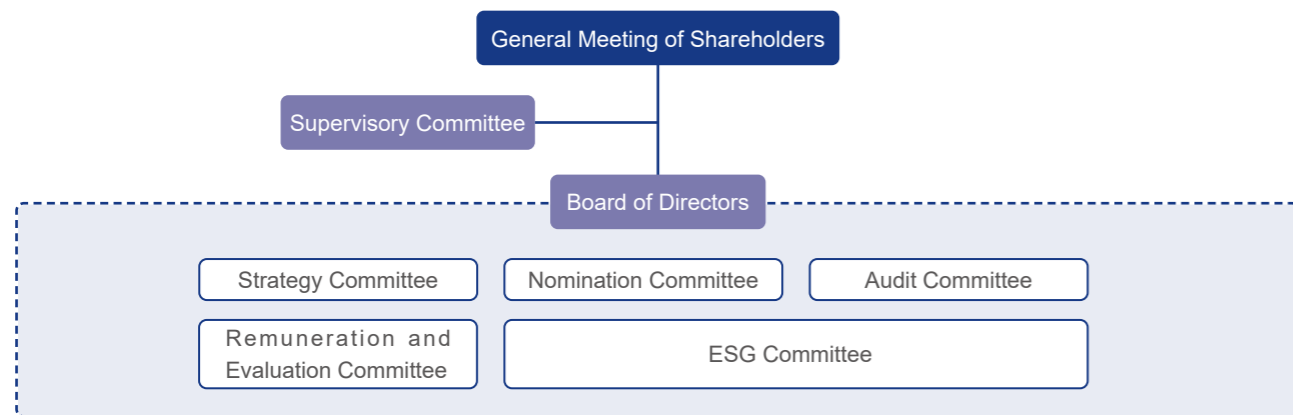



We strictly follow the Company Law of the People's Republic of China, Securities Law of the People's Republic of China, Anti-Unfair Competition Law of the People's Republic of China, Anti-Monopoly Law of the People's Republic of China, Regulations on Corporate Governance of Listed Companies, Stock Listing Rules of the Shenzhen Stock Exchange, Guidance of Shenzhen Stock Exchange No. 1 for the Application of Self-Regulation Rules for Listed Companies - Standardized Operation of Main Board Listed Companies, Guidelines No. 17 on Self-Regulation of Listed Companies on Shenzhen Stock Exchange - Sustainable Development Report (Trial) and relevant regulations of regulatory authorities such as the CSRC, and develop and vigorously implement the Articles of Association, Rules of Procedure for General Meeting of Shareholders, and other internal management systems, to continuously improve the internal control system, strive to reduce risks, and ensure the effective operation of the corporate governance structure.

6.1.3 Actions and practices

6.1.3.1 Board of Directors independence and diversity

We understand and firmly believe that the diversity of board members greatly benefits corporate performance and have defined the requirements for board diversity policies in the Sustainable Development Commitment.

- 

We consider various factors for the diversity of board members, including gender, age, nationality, cultural and educational background, professional experience, skills, knowledge, industry or other experience, expertise, independence, and term of service, when appointing optimal board members.
- 

We also take factors into account based on our business model and specific needs at any given time.
- 

The Nomination Committee under the Board of Directors periodically discusses measurable goals for board member diversity and provides recommendations to the Board of Directors.
- 

The Nomination Committee checks diversified factors of the Board of Directors annually and supervises the implementation of this policy to ensure its effectiveness.

As of December 31, 2023, we have nine board members, including three independent directors. Each director possesses rich industry experience and two directors have financial and legal affairs management backgrounds with professional risk management acumen.



Ninestar has a total of **9** board members



Including three **3** independent directors

In the pursuit of superior corporate governance, enhancing board independence is an important part. Board of Directors independence ensures that we make decisions in an objective and fair manner to better protect the rights and interests of all stakeholders. During the Reporting Period, we give ongoing training sessions and take improvement measures to strengthen the management of board independence. In March 2024, one of our directors resigned from their senior management duties, resulting in improved board independence. We are well aware that independent directors give full play to their professionalism in each committee under the Board of Directors with checks and balances and are committed to enhancing the proportion of independent directors, engaging female directors, and other tasks so as to gradually enforce our board independence and diversity.

No.	Role	Name	Number of the boards of listed companies where the director served (including Ninestar)	Focus areas	Strategy Committee	Remuneration and Evaluation Committee	Nomination Committee	ESG Committee	Audit Committee
1	Director	Wang Dongying	1	Strategy development/ corporate governance/ talent development	√			√	
2	Director	Zeng Yangyun	1	Corporate operation/ technical consulting			√		
3	Director	Kong Dezhu	1	Corporate operation/ business management	√			√	
4	Director	Wang Yonghua	1	Public relations/ financial management				√	√
5	Director	Zhang Jianzhou	1	Corporate operation		√		√	
6	Director	Meng Qingyi	1	Strategy consulting	√				
7	Independent director	Tang Tianyun	2	Financial management/ risk management		√		√	√
8	Independent director	Xiao Yongping	2	Legal consulting/risk management	√		√		√
9	Independent director	Wang Guoyou	1	Artificial intelligence and automation	√	√	√	√	
Proportion of independent directors					40%	67%	67%	33%	67%

6.1.3.2 Performance of the General Meeting of Shareholders, Board of Directors, and Supervisory Committee

We develop and abide by the Rules of Procedure for the General Meeting of Shareholders, Special Working Meeting System for Independent Directors, Implementation Rules for the Audit Committee, Independent Director System, Rules of Procedure for the Board of Directors, Implementation Rules for the Nomination Committee, Rules of Procedure for the Supervisory Committee, and Implementation Rules for the Remuneration and Evaluation Committee to further improve our corporate governance structure, establish sound internal management and associated systems, and promote their effective implementation.

2023	General Meeting of Shareholders	Board of Directors	Supervisory Committee
Number of meetings held (time)	4	9	8
Number of proposals approved (item)	22	48	37

Special committees are vital components of corporate governance. In order to further enhance the decision-making quality, effectively monitor the management, ensure the compliance of our operational decision-making, and fully safeguard the rights and interests of shareholders, during the Reporting Period, our special committees held several meetings complying with associated rules of procedure, so as to enforce our risk management and achieve high-quality, sustainable development.

Special committee	Name of committee member	Number of meetings held in 2023	Number of attendances by proxy	Attendance rate (%)
Audit Committee	Wang Yonghua	6	0	100
	Tang Tianyun		0	100
	Xiao Yongping		0	100
Nomination Committee	Zeng Yangyun	1	0	100
	Xiao Yongping		0	100
	Wang Guoyou		0	100
Remuneration and Evaluation Committee	Zhang Jianzhou	5	0	100
	Tang Tianyun		0	100
	Wang Guoyou		0	100
Strategy Committee	Wang Dongying	2	0	100
	Kong Dezhu		0	100
	Xiao Yongping		0	100
	Wang Guoyou		0	100
ESG Committee	Meng Qingyi	1	0	100
	Wang Dongying		0	100
	Kong Dezhu		0	100
	Wang Yonghua		0	100
	Zhang Jianzhou		0	100
	Tang Tianyun	0	100	
	Wang Guoyou	0	100	

We believe that ongoing and targeted training contributes to strengthening the effectiveness of the Board of Directors and helps directors deepen their understanding of our operation and business management. In 2023, we organized and held online and offline training in various forms for our directors, supervisors, and senior management, with training content covering laws and regulations, regulatory requirements, industry development, and other themes.



During the Reporting Period, our directors, supervisors, and senior management received

27 outsourced training sessions

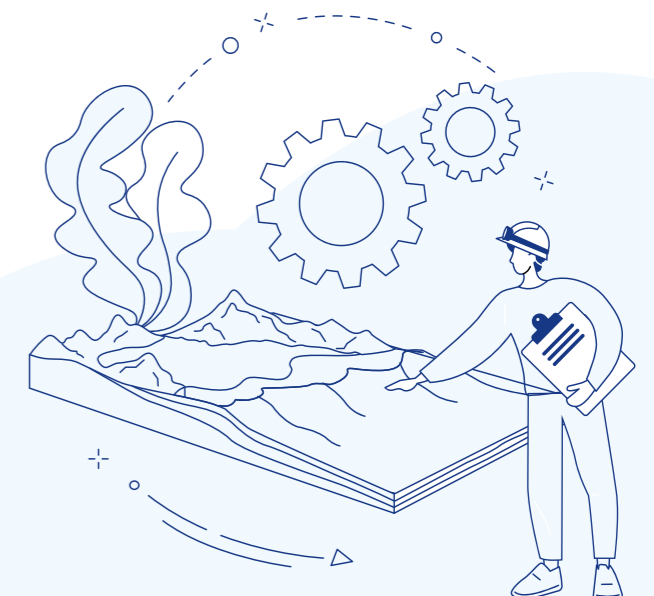

6.1.3.3 Investor relations management

Investor relations management serves as an integral part of corporate governance for listed companies. Through effective communication with investors, we can better understand investors' expectations and demands, thereby optimizing the decision-making process and making corporate governance more transparent and efficient. We have formulated the Investor Relations Management System to build and maintain trust with investors through proactive, honest, and transparent communications, reduce information asymmetry, improve market trust, increase corporate value, and fully protect investors' rights and interests, ensuring that the management of investor relations is in conformity with the following four principles.

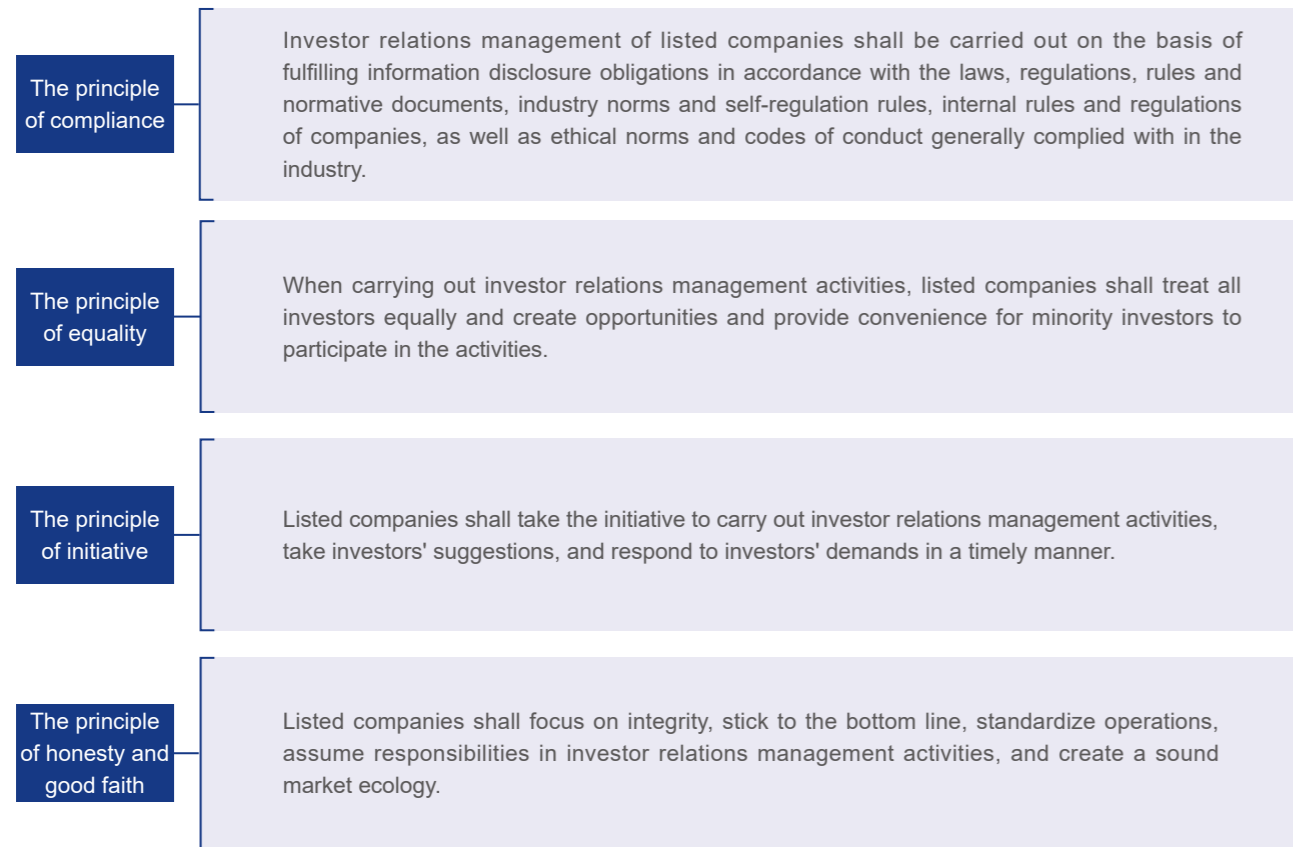

In 2023, we openly disclosed six investigations on investors and over 271 investment agencies engaged in the investigation online and offline. The number of investors engaging in the investigations reached more than 370. We accepted over 10 investigations by investment agencies. A total of seven seller agencies were contacted closely in the whole year.



6.1.3.4 Management of conflict of interest

We abide by the Securities Law, Company Law, and other relevant laws and regulations, strengthen internal risk management, and identify and discover potential conflicts of interest to ensure our decision-making process is fair and transparent and fully protect the legitimate rights and interests of minority shareholders.

Additionally, in order to maintain the decision-making fairness and transparency for related party transactions and avoid conflicts of interest, we comply with laws and norms regarding related party transactions, prohibit directors, supervisors, and other senior management personnel from harming the legitimate rights and interests of the Company and minority shareholders, ensure transactions are fully and internally controlled and supervised, follow the principles of fairness, and guarantees fair and reasonable pricing. If any director or independent director is an interested party to the matters for deliberation, the related director is required to make a declaration on his or her initiative and abstain from voting and cannot cast votes on behalf of other directors in order to reduce the circumstances under which the conflict of interest may affect judgment or independence. For major related party transactions, we engage a third party with professional qualifications to conduct an audit or assessment to ensure the fairness and reasonableness of the transactions and consolidate the management of conflict of interest.

6.1.3.5 Salary management and performance incentive

Aiming to build a fair, reasonable, and competitive salary system, we have formulated the Comprehensive Salary Management System, which focuses on aspects such as salary structure design, salary determination, and performance appraisal. This system successfully promotes human resources development by attracting, motivating, and retaining talent, thereby facilitating the achievement of our strategic objectives.

Five principles of comprehensive salary management:

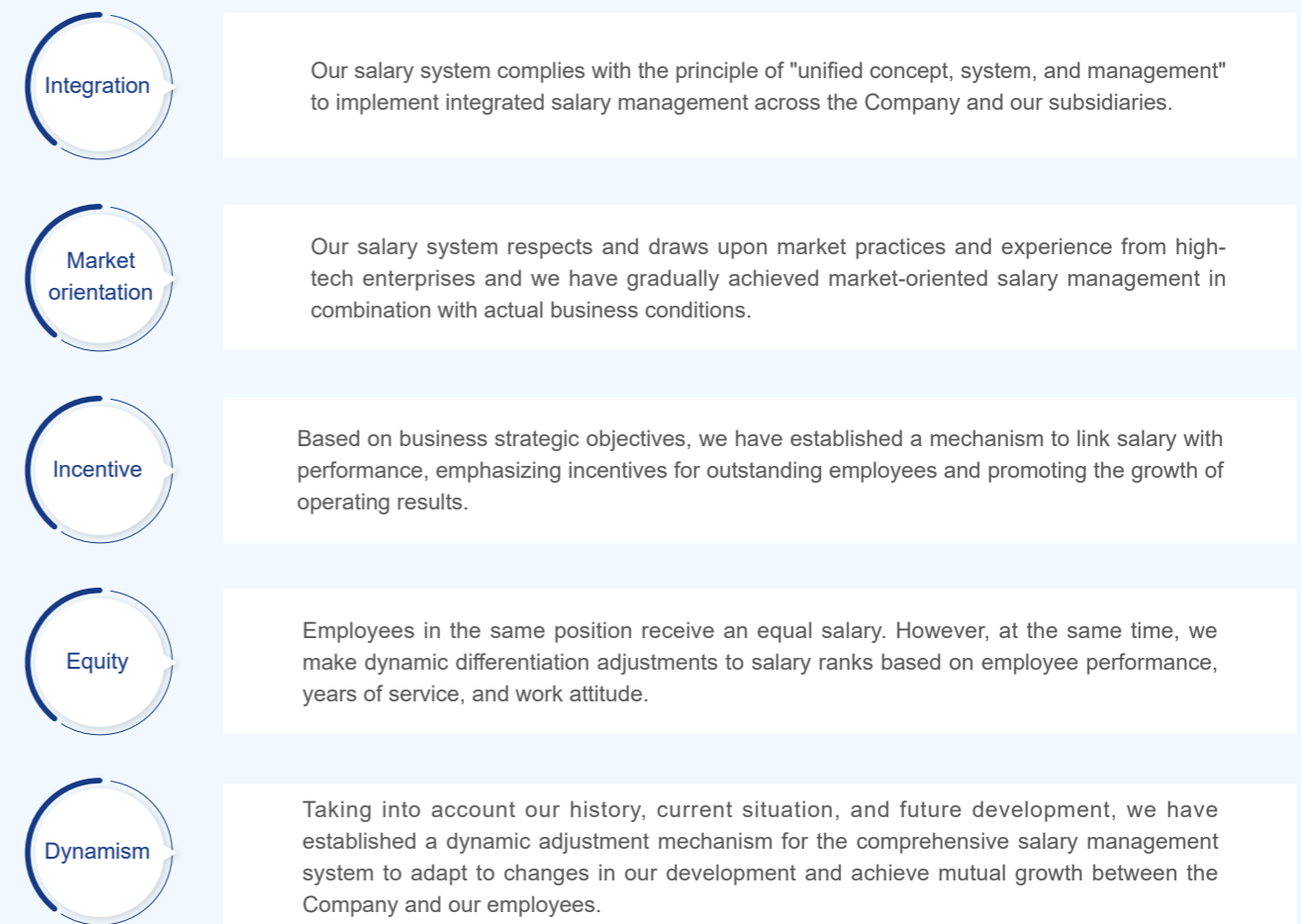

In addition, based on our existing ESG management system, we decompose the overall ESG management into various departments and subsidiaries to clarify the work objectives and responsibilities of each entity and urge departments to integrate the requirements for sustainable development into their current responsibilities. By establishing the mechanism that links performance appraisal with salary, we associate certain ESG indicators with employee rankings and promotions, aiming to stimulate the motivation of all employees and guide them to voluntarily engage in sustainable development practices.

6.1.3.6 Protection of the rights and interests of minority shareholders

We fully respect the rights and interests of all shareholders and attach importance to safeguarding the equal rights and interests enjoyed by minority shareholders. We have formulated and implemented the Management Policies for Information Disclosure, Accountability Policy for Material Errors in Information Disclosure of the Annual Report, Management Policies for Inside Information and Insiders Reporting and Registration, Internal Reporting System of Material Information, and Management Measures for Separate Counting of Votes for Minority Shareholders. All directors, supervisors, and senior management personnel ensure the truthfulness, accuracy, and completeness of information disclosure, and continuously strengthen information transparency management to safeguard the legitimate rights and interests of the Company and our shareholders, especially public shareholders.

We fully protect minority shareholders' rights to know and make decisions and issue an announcement before convening the general meeting of shareholders. The general meeting adopts a combination of on-site voting and online voting to ensure that all shareholders can fully exercise their rights. Meanwhile, we disclose the results of separate vote counting from minority shareholders in the announcement of resolutions of the general meeting for relevant proposals involving separate vote counting from minority shareholders, to fully reflect the opinions of minority shareholders.

In addition, we increase information transparency and strengthen communication with investors and keep communication channels open by telephone consulting, receiving visiting investors and roadshows, to respect and protect the rights and interests of minority shareholders fully.

In 2023, we issued four regular announcements and 123 interim announcements.

Ninestar issued four regular announcements and 123 interim announcements.



6.1.4 Metrics and targets

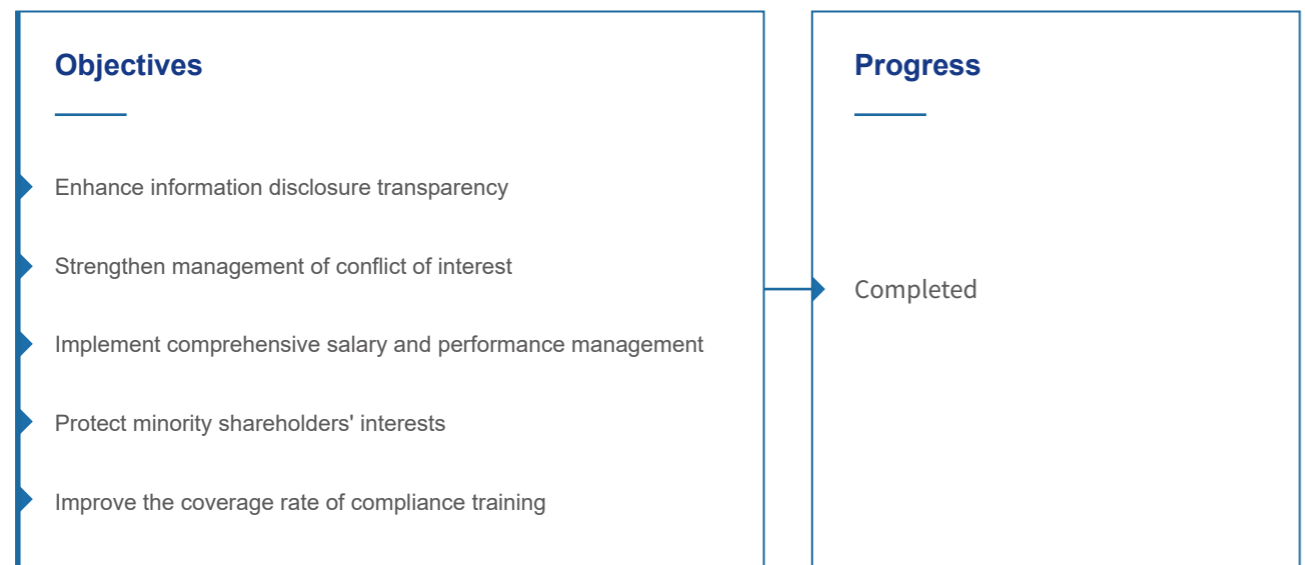

6.2 Risk control

6.2.1 Concept

A well-established risk control mechanism contributes to stable corporate operations, improves decision-making efficiency, and enhances corporate competitiveness. Adhering to the "forward-looking, comprehensive, systematic, flexible, and sustainable" risk management concept, we have formulated a management structure, risk identification process, and countermeasures that meet the business development and constantly raise our risk management level through defining risk management objectives to guarantee the orderly business development in the long term.

6.2.2 Strategies

We have set up the Audit Department at the headquarters, which is responsible for supervising the establishment and implementation of internal control systems, as well as compliant business operations. The Audit Department regularly reports to the Audit Committee and is responsible to the Audit Committee. The Audit Committee consists of two independent directors with professional risk management knowledge. The Audit Committee quarterly reviews the relevant internal audit work in the Company and makes a report to the Board of Directors.

In addition, the Legal Department at the headquarters takes charge of coordinating the Company's legal compliance management. Under its leadership, the legal departments at different levels strictly control the high-risk business areas in the process of enterprise operation in combination with operation management practice and carry out targeted compliance risk management, including contract management, intellectual property rights risk management, and data compliance management.

We have established a compliance management system from top to bottom and a comprehensive risk response and management system to actively standardize business operations. We conduct standardized management through systems and policies such as the Compliance Management Program, Risk Investment Management Policies, Internal Audit Policy, Internal Control Management Policies, and Internal Control Risk Matrix and Risk List.

We advance our risk management strategies by resolving around the following directions:

- Risk identification** → Identify potential risks, such as market risk, compliance risk, operational risk, and climate change, through comprehensive internal and external information collection and analysis.
- Risk assessment** → Assess potential loss severity and probability through the scientific methodology for identified risk types.
- Risk priority ranking** → Prioritize risks and determine risks that require key management and control based on risk assessment results.
- Formulation of risk response strategies** → Formulate corresponding risk strategies, such as purchasing insurance, canceling high-risk projects, and strengthening internal controls, for every important risk.
- Risk monitoring and reporting** → Monitor risk changes on a regular basis and report risk management progress and results to relevant personnel.
- Risk communication and training** → Enhance employee awareness and understanding of risk management and cultivate a risk culture through effective communication and training.
- Emergency plan formulation** → Develop emergency plans for potential major risks to enable swift response and minimize the impact of the risks.

6.2.3 Actions and practices

6.2.3.1 Internal audit

We have established annual internal control audit plans guided by the risks through regular compliance reviews surrounding our operation and control. The Audit Department annually conducted operation management and specialized internal control audits on each subsidiary and business within our operational scope. In 2023, we conducted comprehensive audits from various perspectives, including contract review, product development review, and return business review, using methods such as on-site audits, remote audits, inventory checks, interviews, and analytical procedures. We completed a total of 19 internal control audit projects covering operation outlets in nine cities and issued corresponding audit reports.

In 2023, we identified and discovered the following risks in our internal business audits through refining risk assessment, strengthening risk monitoring, improving management procedures, conducting risk training, and other methods to realize closed-loop risk management.

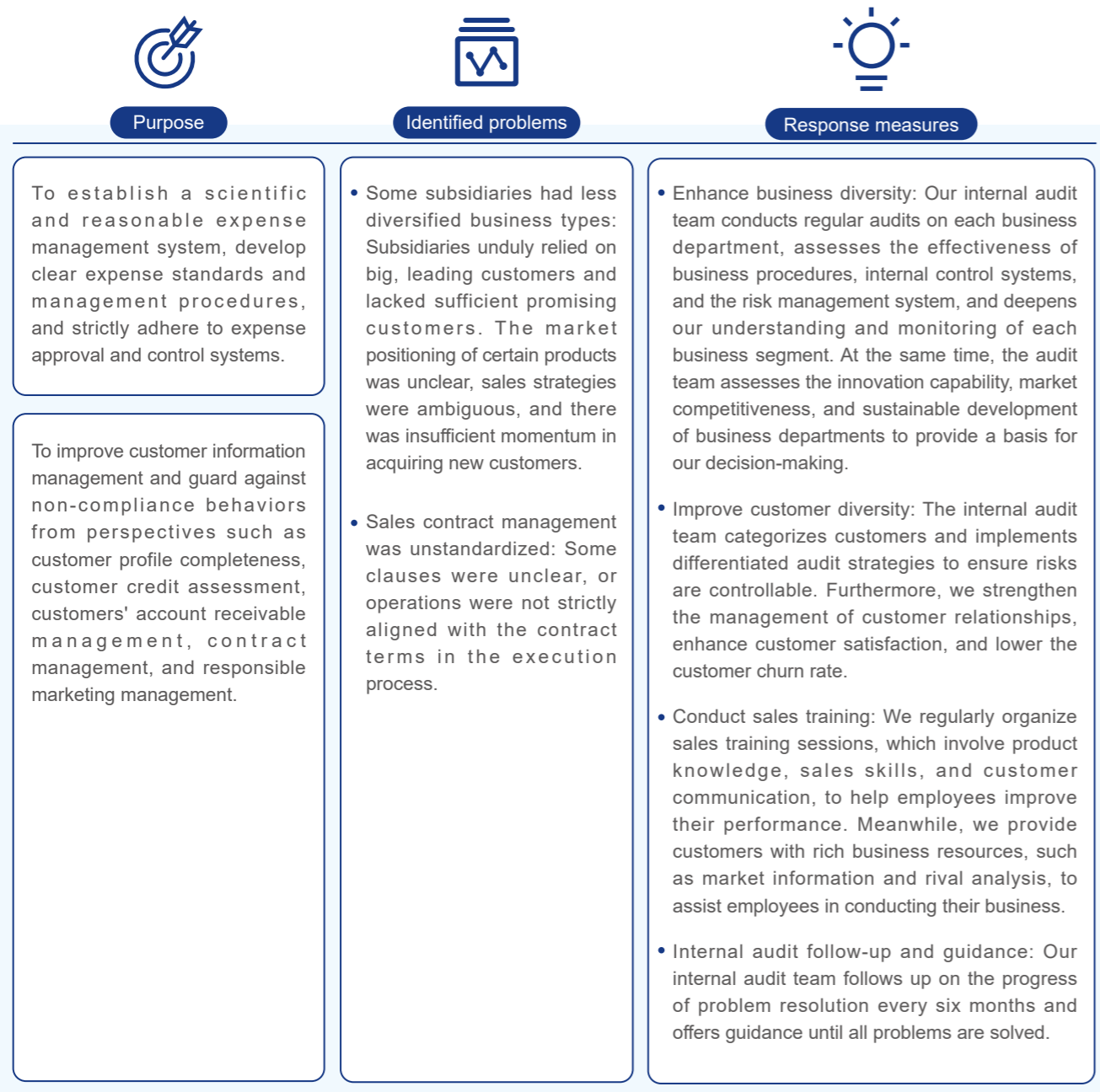

6.2.3.2 External audit

We engage a third-party accounting firm each year to conduct an audit of our annual financial information and issue a third-party auditing report, fully ensuring information transparency and the stakeholders' right to know.

Additionally, we engage a professional third-party institution to audit our internal control management system and issue the Internal Control Audit Report.

6.2.3.3 Consolidate compliance management

As the regulatory environment becomes stricter at home and abroad, we are confronted with new business patterns and external risks. In order to carry out compliance management in all professional areas, integrate the compliance requirements into business procedures and the compliance culture into corporate values, and ensure that our operation management and employee performance comply with laws, regulations, and industry standards in various countries and regions, in 2023, we formulated the Compliance Management Program and resolved around three dimensions, namely, key compliance, product compliance, and basic compliance, to plan the management of seven compliance areas, sticking to the bottom line of compliance. Through improving the compliance management system, optimizing the compliance management and operation mechanism, and establishing a compliance management guarantee mechanism, we implement our holistic compliance management in an orderly manner, clearly propose compliance management requirements for specific areas in a scenario-based manner, and define the bottom line of behaviors.

6.2.3.4 Establish a compliance management operation mechanism



6.2.3.5 Establish a compliance management guarantee Mechanism

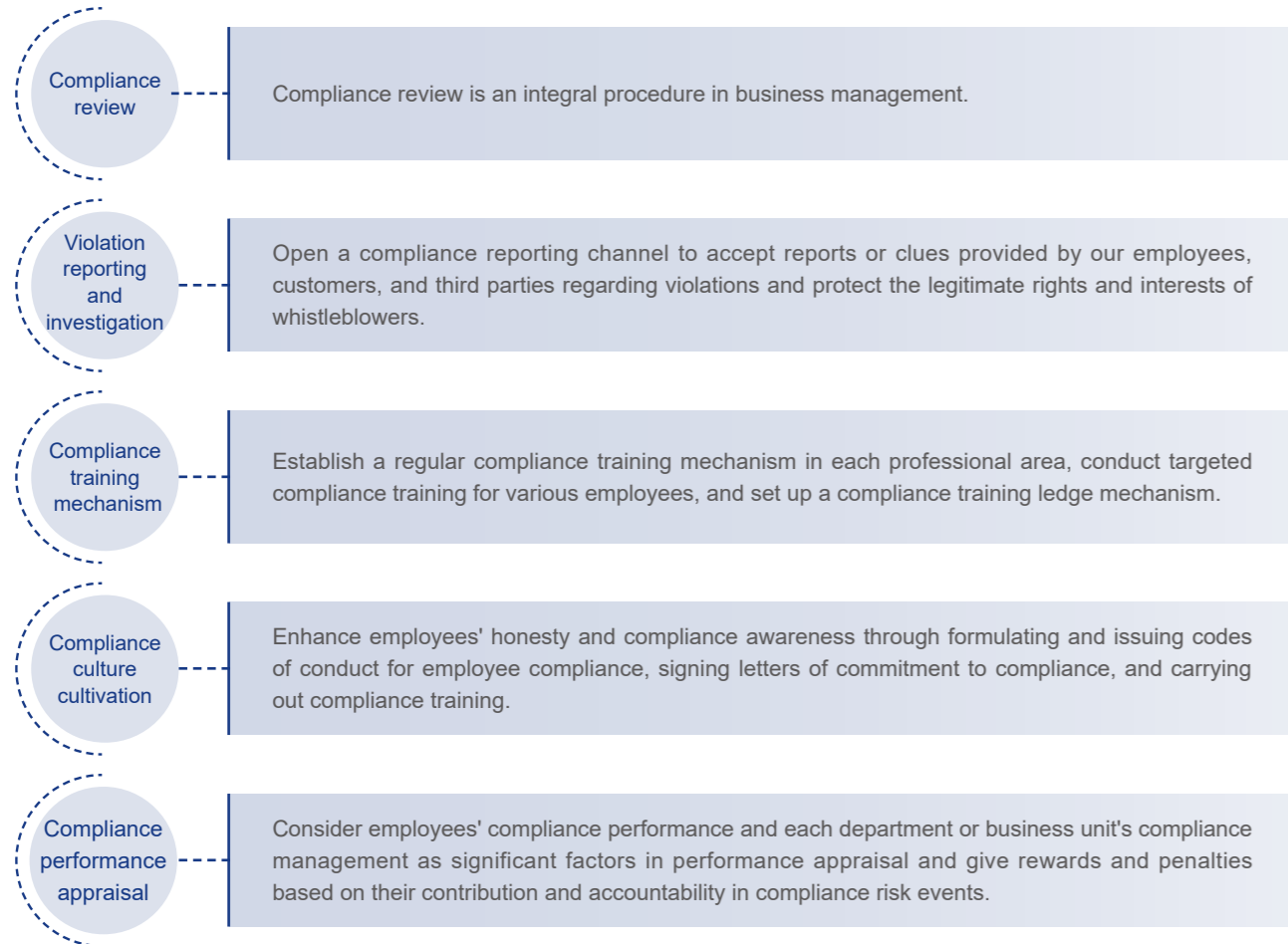

In order to ensure the effective function of the compliance management guarantee mechanism, we have formulated the implementation roadmap for compliance management planning in the next three years.



Implementation Roadmap for Compliance Management Planning

6.2.3.6 Hold legal compliance training

In 2023, we held multiple compliance training sessions and law publicity activities, provided training regarding cases, important regulations, patent compliance, and general legal knowledge, and conducted special training on risk audits and internal system establishment for our audit personnel. During the Reporting Period, we carried out 20 legal compliance training sessions within the Company, with 227 person-times.



We carried out

20 legal compliance training sessions within the Company



with

227 person-times



6.2.4 Metrics and targets

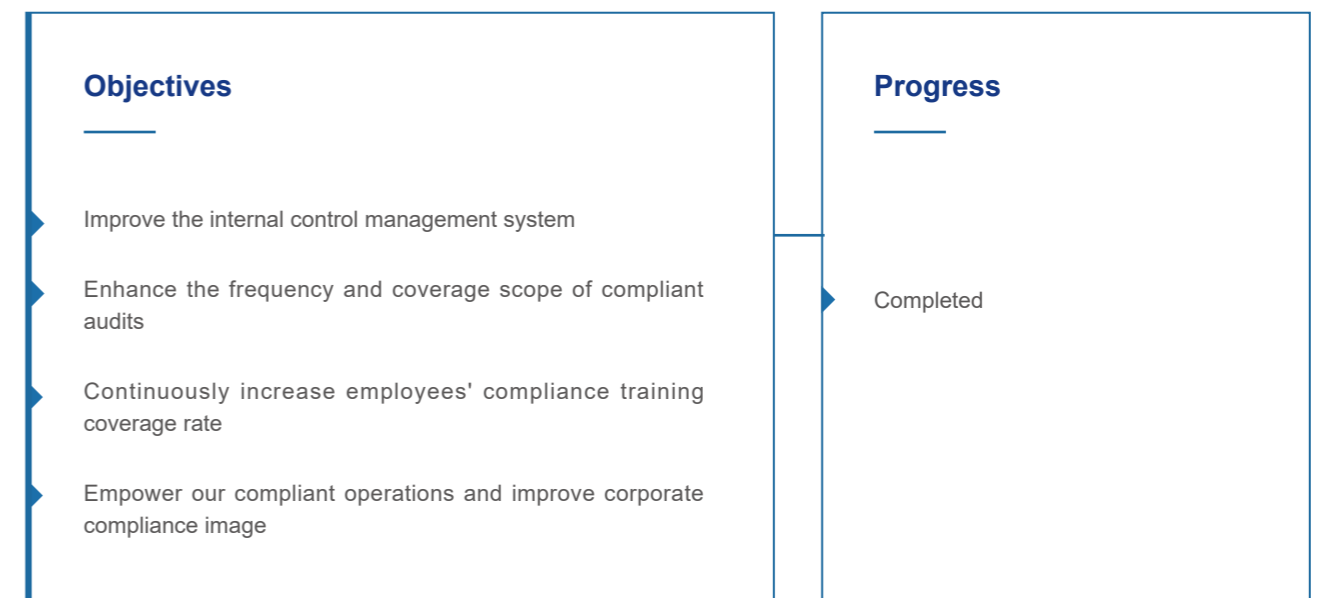

6.3 Business ethics and anti-corruption

6.3.1 Concept

Ninestar upholds the corporate values of "loyalty, truth-seeking, innovation and being win-win", complies with laws and regulations, the amfori BSCI Code of Conduct (hereinafter referred to as "BSCI Code of Conduct"), and "the Responsible Business Alliance Code of Conduct" (hereinafter referred to as "RBA Code of Conduct"), prioritizing integrity in management and scrupulously abiding by business ethics. We resolutely oppose any form of illegal transfer of benefits and enhance employees' business ethics through improving systems, defining standards, optimizing procedures, and strengthening training. Furthermore, we are committed to leveraging our influence in the industry to impose business ethics constraints on stakeholders, including suppliers. We strive to create a business environment based on transparency, honesty, fairness, and integrity.

6.3.2 Strategies

We have established a top-down and effective business ethics governance structure. The Audit Committee leads our business ethics management and is responsible for leading and urging the development of an anti-bribery, anti-corruption, and anti-fraud culture within the Company. The Human Resources Department and Audit Department are the standing bodies for our business ethics management and take charge of the implementation of business ethics management measures.

In addition, we set up the Integrity and Self-discipline Committee in 2023. The Integrity and Self-discipline Committee serves as the independent management body and has established four lines of defense to fulfill its responsibilities for supervising and managing the Company's integrity and self-discipline through routine supervision and promotion, self-discipline publicity, and the establishment and improvement of a preventive integrity control system.

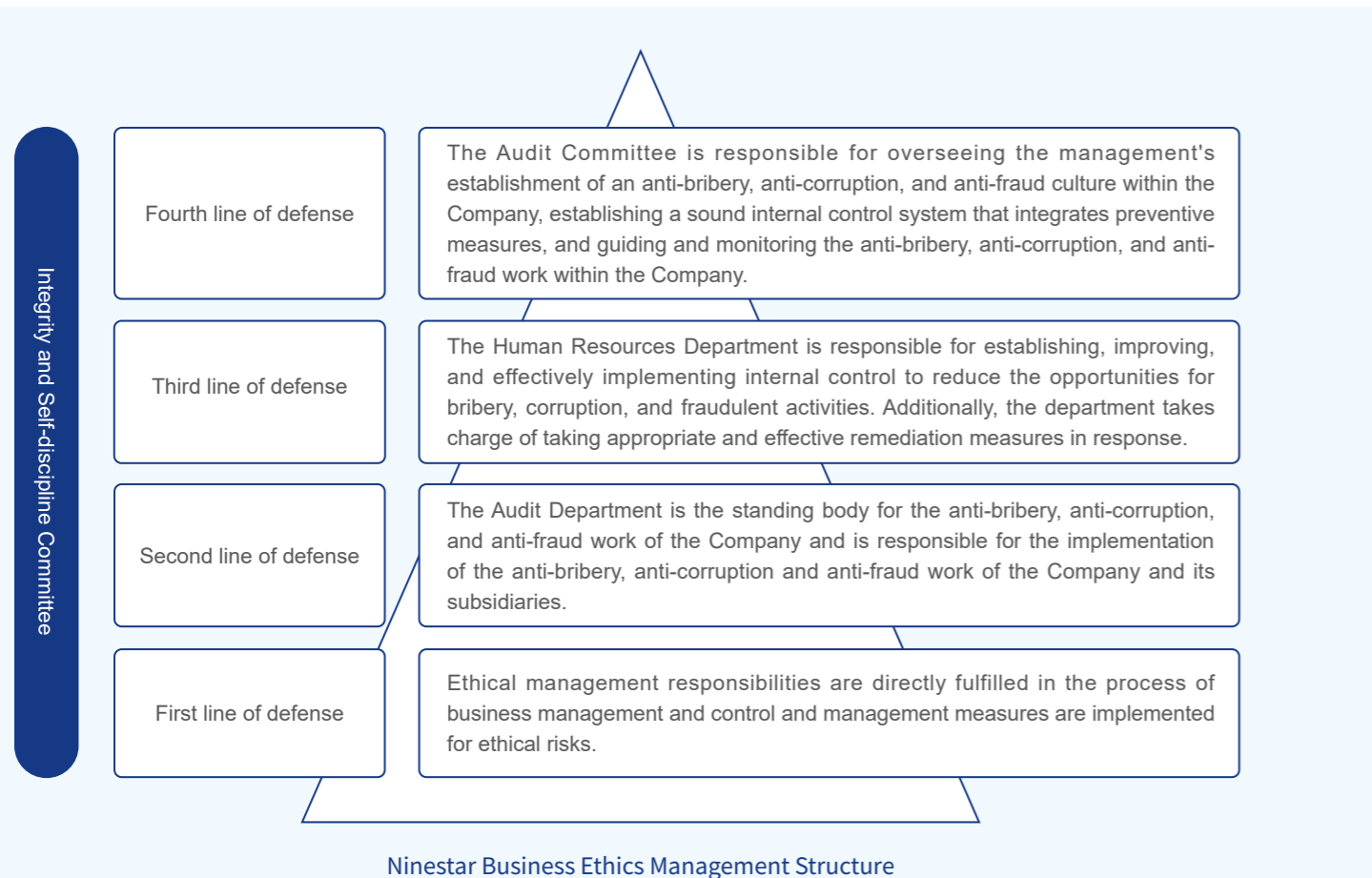

We have formulated and disclosed the Ninestar Anti-bribery and Anti-Corruption Management System to define corruption behaviors, management duties at all levels, and the reporting management mechanism. In order to strengthen business ethics management and provide standards, we have developed the Integrity and Self-discipline Management System, Procurement Management Regulations, Supplier Management Regulations, and other systems to clarify ethical standards and management requirements for all employees and suppliers.

"Three-prohibit" business ethics principle

Complying with the bottom-line requirements for compliance during our business management, we have formulated the "three-prohibit" business ethics principle to guide and support business decision-making and routine operation and management.

- Prohibit employees from accepting any commission, donation, or sponsorship during the Company's operation activities.
- Prohibit any employee from making facilitation payments to accelerate or ensure normal government actions.
- Prohibit any form of political donations or any form of donation or sponsorship towards organizations supporting illegal activities or violating international conventions, organizations supporting terrorist activities, or organizations with religious, gender, or other forms of discrimination.

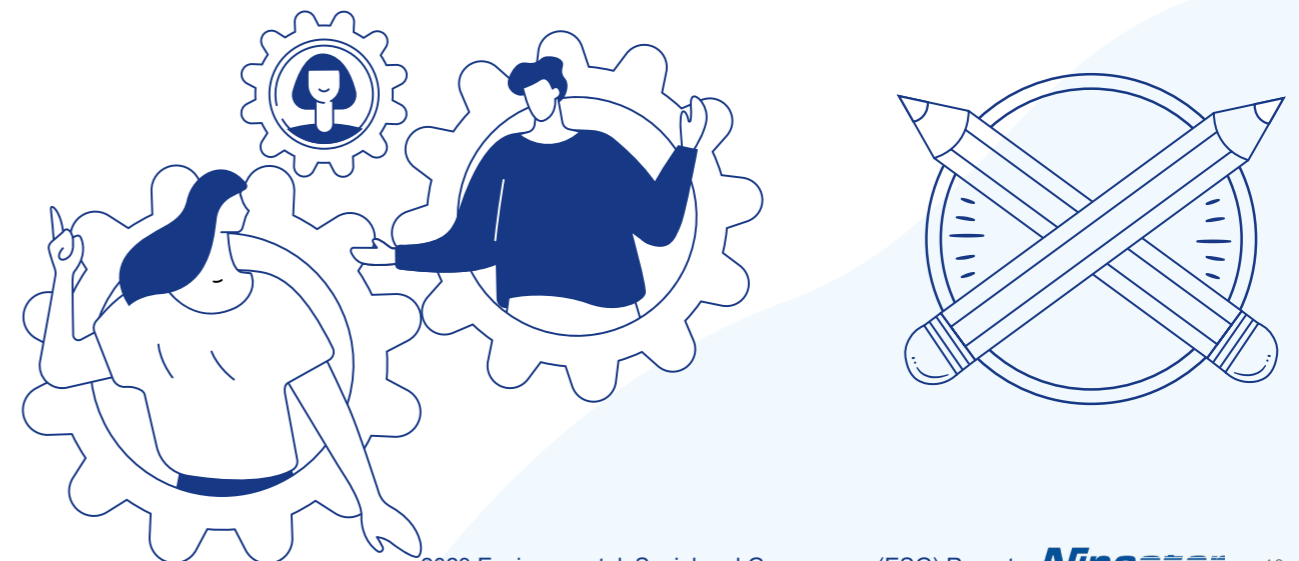

6.3.3 Actions and practices

6.3.3.1 Ethics standards audit

We conduct the ethics standards audit annually for business departments and subsidiaries, including the anti-corruption audit and internal control audit. In addition to routine audits, we carry out comprehensive ethics standards audits for all business types every three years. In addition, we conduct off-office audits and implement integrity audits for key positions, such as procurement, R&D, and engineering positions, of branches where we operate through the IT management system.

In 2023, Ninestar conducted ethics standards audits 19 times to conduct stricter reviews of internal ethics and compliance standards and comply with commitments to high-standard business ethics and transparency. We successfully identified one case of business ethics violation and turned it over to the judicial authorities through a well-established internal reporting system and audit procedures. In order to strengthen employees' integrity and self-discipline awareness, we have deepened our business ethics management and adopt a zero-tolerance attitude towards any ethical and legal violations through internal notifications, training enhancement, and other open and transparent approaches.

6.3.3.2 Upgrade anti-corruption management

In 2023, while focusing on improving system revisions and advancing structure upgrades, we clarified management standards and strengthened independent supervision and management so as to constantly consolidate our anti-corruption management practices.

System improvement

We revised the Integrity and Self-discipline Management System. The Human Resources Department, Audit Department and other associated organizations have jointly managed the Company's integrity and self-discipline and defined respective management responsibilities, further expanding the management scope of our integrity standards. Moreover, we increased management standards and requirements for sensitive position management, gift handling, supervision and audits, and measures for rewards and penalties. We also added the Implementation Rule for Integrity and Self-discipline Review to clarify management standards and procedures for reporting and define handling standards for employees' corruption behaviors with varying degrees and consequences.

Independent supervision

We set up an Integrity and Self-discipline Committee composed of directors and senior management personnel. The Integrity and Self-discipline Committee is responsible for special integrity and self-discipline management, including organizing routine integrity management, strengthening integrity publicity, improving institutional system establishment, coordinating audits on integrity management, and appraisal and punishment. The Integrity and Self-discipline Office is the standing body of the Integrity and Self-discipline Committee and takes charge of developing sound regulations and standards regarding self-discipline management, organizing integrity promotion activities, accepting and investigating employee complaints and reports regarding disciplinary and regulation violations, establishing a comprehensive integrity and self-discipline management file, and register gifts for management.

6.3.3.3 Cultivate integrity culture

Integrity culture constitutes an important part of Company Culture. Strengthening integrity culture construction is conducive to internal corporate management through standards and systems and can reduce corruption and unethical practices, avoiding resource waste and poor efficiency caused by improper management.

Regular training for all employees

Business ethics training is carried out each year for all employees, including our board members, interns, and outsourced employees. Moreover, we implement standardized management for employee conduct and promote integrity-related laws, regulations, and internal standards through displaying integrity publicity posters, organizing integrity lectures, and sharing warning case studies. In 2023, 100% of our employees (including interns and part-time employees) received integrity and self-discipline training.

Special training

During the Reporting Period, we provided all regular employees at senior, middle, and primary levels with anti-corruption and business ethics training. With case teaching, online teaching, excellent enterprise communication and other methods, integrity training is conducted for employees each quarter. In 2023, we conducted six special training sessions on anti-corruption and business ethics construction.



Company-wide signing

All employees are required to comply with Employee Integrity and Self-discipline Regulations, with a 100% signing rate.

Promote integrity across partners

We conduct regular and specialized integrity training for suppliers every year. We require all suppliers to sign the Agreement on Business Ethics Adherence, which is centrally archived and managed by the President's Office. In 2023, the signing rate for the Agreement on Business Ethics Adherence reached 100% among suppliers. We incorporate integrity standards into the supplier management procedures and require suppliers to develop policies and systems related to business ethics and anti-corruption, ensuring integrity in our cooperation.

6.3.3.4 Improve the anonymous reporting mechanism

Aiming to create an honest enterprise culture atmosphere, we have set up a standardized reporting management process and public reporting channels, including a dedicated telephone line, exclusive mailbox, QR codes, physical letterbox, and other reporting approaches. We have placed promotional materials in various locations within the Company, such as factory areas, office buildings, employee cafeterias, and residential areas, to encourage all employees, suppliers, business partners, and other relevant parties to anonymously report any instances or potential instances of corruption, fraud, or violation through the aforementioned reporting approaches.



Other anonymous reporting channels:

- Email: lianjiezilv@ggimage.com
- Tel.: 0756-6258192
- Fax: 0756-8539856

Ninestar accepts anonymous reporting and encourages real-name reporting so that we can provide timely feedback on the investigation's progress. We undertake to fully protect the reporter's personal information and legal rights to protect the reporter from being framed and retaliated against. We require that the name, company, department, position, contact, and other details of the whistleblower or the reporter can be used only when we investigate and receive evidence from the whistleblower or the reporter or when we inform the whistleblower or the reporter of the handling results. It is not allowed to be used in any other situation. In regard to personnel responsible for integrity and self-discipline management, we require them to strictly maintain the confidentiality of whistleblower identities and related materials, protecting the legitimate rights and interests of whistleblowers. For the acts infringing the reporter's legal rights and interests, we will impose dismissal, termination of employment or other means. And any violation of the law will be subject to transfer to the judicial authority for legal treatment.

Upon receiving reports of violations or suspected violations of integrity and self-discipline practices, the Audit Department of the Company takes charge of promptly recording and reporting such acts to the Integrity and Self-discipline Committee. The Human Resources Department will then intervene and conduct investigations. If the reported matters are verified to be true, we will provide the whistleblower with appropriate rewards in accordance with relevant reward and penalty management measures. For reported matters involving illegal or criminal activities, we will transfer them to the judicial authorities for proceedings.

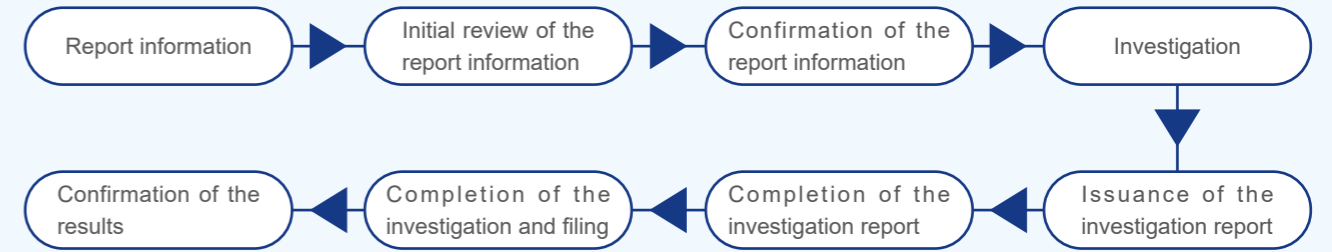

Ninestar's reporting handling process

Additionally, we have also established an anonymous feedback channel for employees to provide rational suggestions and collect appeals from employees.

During the Reporting Period, we received a total of 11 reports regarding integrity and self-discipline practices, all of which were verified to be true. The Company's Integrity and Self-Discipline Committee is currently following up on these cases, and one case has been transferred to the judicial authorities. We will continue to take concrete actions to combat corruption behaviors.

6.3.4 Metrics and targets

Objectives	Progress
<ul style="list-style-type: none"> Promote regular business ethics audits Improve ethics standards audit and anti-corruption policy audit systems Refine the decision-making management mechanism based on business features and advance departments to participate in integrity remediation Perfect employee appeal and feedback management mechanism to listen to their opinions on anti-corruption work Promote integrity across partners and strengthen integrity management for stakeholders including suppliers Expand the training scope of business ethics standards for employees Employees comply with Employee Integrity and Self-discipline Regulations with a 100% signing rate 	Completed

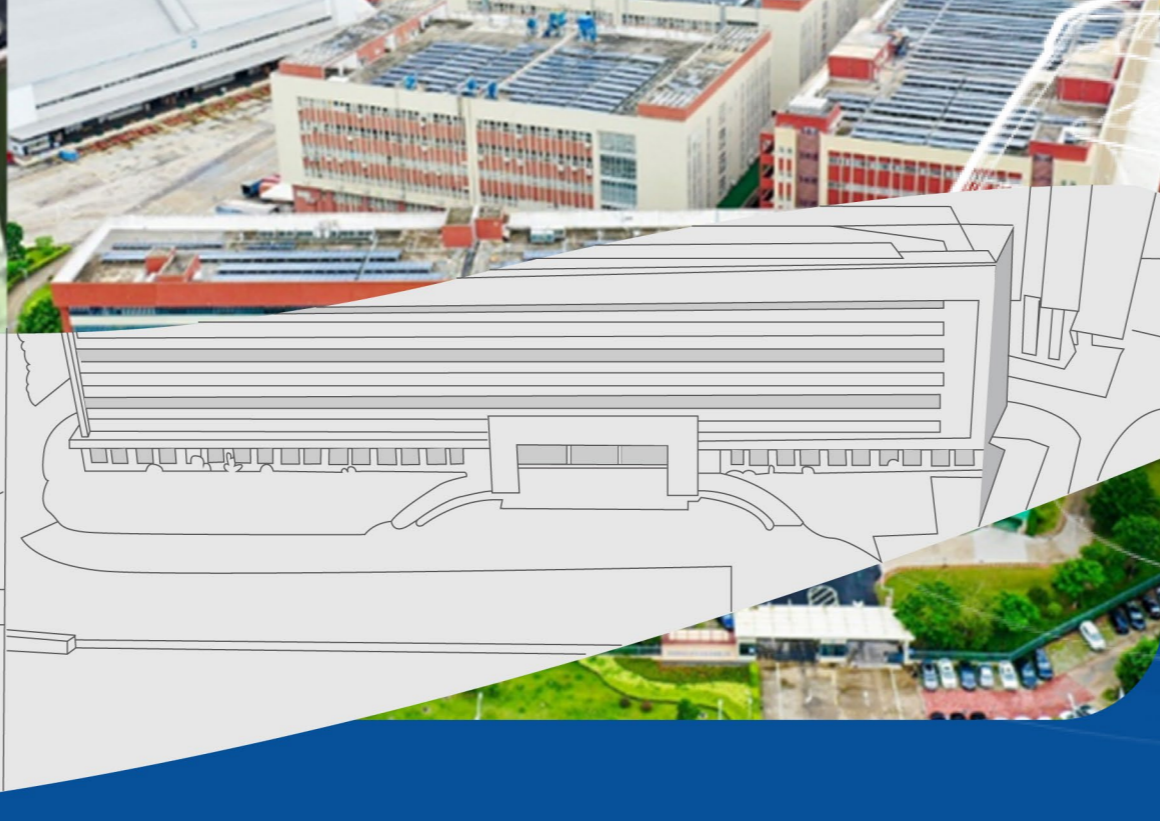
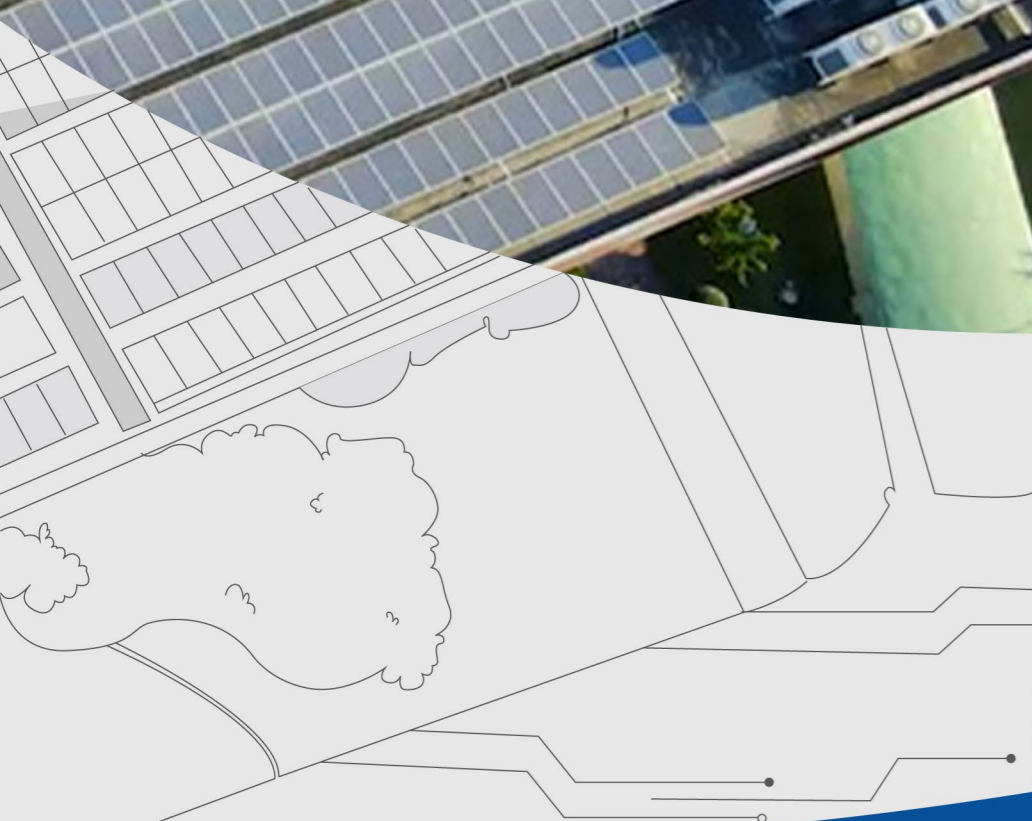

7. Social

We remain committed to building a sustainable and responsible supply chain, ensuring product quality and safety, and establishing an effective information security and privacy protection mechanism. We understand that employees are the driving force for our long-term growth and the embodiment of our values. Therefore, we prioritized a "people-oriented" approach, safeguarding the legitimate rights and interests of our employees, implementing diverse and equitable policies, and establishing a fair, just, and transparent career development system to ensure equal growth and progress opportunities for all employees. Additionally, we enhance the management of occupational health and safety, providing a secure working and living environment for our employees during work. Furthermore, we actively engage in public welfare activities, assuming social responsibilities and contributing to various fields such as community support, rural revitalization, and environmental protection.

Material issues	Response to GRI indicators	Chapter Navigation Contents
• Responsible supply chain management	• GRI 204	7.1 Responsible Supply Chain Management
• Employees' rights, interests, diversity and equity	• GRI 308	7.2 Employees' Rights, Interests, Diversity and Equity
• Human capital development	• GRI 401-409	7.3 Human Capital Development
• Occupational health and safety	• GRI 413	7.4 Product Responsibility
• Product responsibility	• GRI 414	7.5 Information Security and Privacy Protection
• Information security and privacy protection	• GRI 416	7.6 Occupational Health and Safety
• Social welfare	• GRI 418	7.7 Community Philanthropy

Response to SDGs



7.1 Responsible Supply Chain Management

7.1.1 Concept

We strictly abide by relevant laws and regulations such as the Civil Code of the People's Republic of China and international supply chain management requirements such as the RBA Code of Conduct, the BSCI Code of Conduct, and the Social Accountability 8000 International Standard (SA8000). We have also revised our Supplier Management Policies and Supplier Selection, Certification, and Onboarding Procedures to strengthen our responsible supply chain management system. In addition, to establish long-term cooperation and a positive relationship with suppliers for mutual growth and progress, we prioritized respecting and safeguarding the legitimate rights and interests of our suppliers through fair competition, reasonable pricing, and prompt payment. We also put forward management requirements for the sustainable development of our supply chain.

During the Reporting Period, we introduced the Supply Chain Sustainable Development Management Policies, integrating sustainable development into our procurement strategy. This encompassed initiatives such as labor management and conflict minerals management within our supply chain. Furthermore, we remain committed to mitigating environmental footprints across our supply chain, disseminating sustainable development management guidelines to all suppliers to enhance their sustainable development management capacities, fortify our sustainable supply chain, and mitigate operational risks.

7.1.2 Strategies

We prioritized two strategies: "enhancing sustainable development risk management among suppliers" and "emphasizing suppliers' ESG management responsibilities". We focused on suppliers' environmental and social accountability, with strict prohibitions against child labor, forced labor, corruption, and malpractices. To bolster responsible supply chain management, we implemented ESG assessment criteria for suppliers and expanded our supplier auditing processes. Recognizing the environmental impacts of supply chain operations, such as resource consumption and waste generation, we are dedicated to reinforcing green management practices throughout the supply chain to drive the green transformation of our supply chain and create an environmentally friendly supply chain.

Strategy 1: Enhancing sustainable development risk management among suppliers

• Hierarchical supplier management

We classified suppliers into classes A, B, and C based on their characteristics and cooperation levels, as well as factors like product/service categories, purchasing expenditures, duration of cooperation, and performance assessment results.

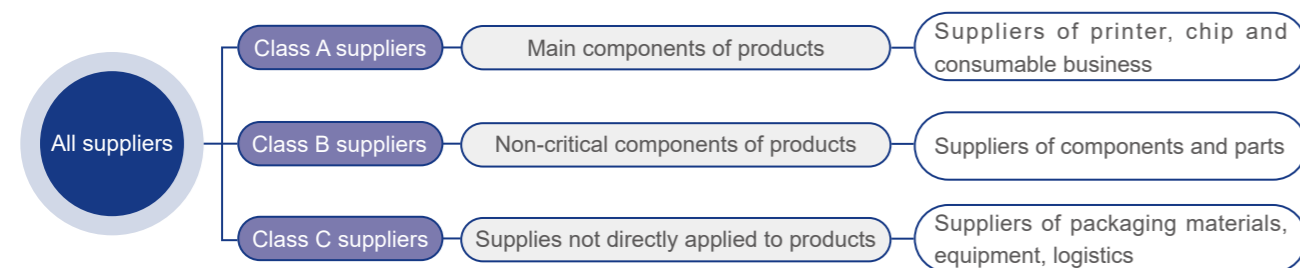

• Ninestar's hierarchical supplier management system

We have established a hierarchical supplier management system to optimize supplier resources, enhance supply chain stability and efficiency, and strengthen the resilience risk management of the supply chain.

• Regular review and assessment mechanism

We have defined the management of regular review and assessment of suppliers, with monthly and annual review plans in place. We incorporated ESG factors such as product quality, compliance management, supply chain labor management, and conflict minerals into performance assessment and categorized superior and inferior suppliers based on regular assessment and on-site audit results to improve the risk management mechanism for suppliers.

Strategy 2: Emphasizing suppliers' ESG management responsibilities

We have revised our whole-process management mechanism for suppliers to emphasize suppliers' ESG management responsibilities. We integrated ESG labor management and conflict minerals criteria into our procurement and supply chain audits. Additionally, we embed ESG management responsibilities for suppliers into cooperation agreements, performance assessments, and on-site inspections. In 2023, we defined ESG management requirements for our key suppliers, incorporating ESG factors into our supplier onboarding and audit so as to thoroughly evaluate our suppliers' performance and reinforce our suppliers' commitment to ESG management responsibilities.

7.1.3 Actions and practices

7.1.3.1 Optimize whole-process supply chain management

Procedure 1: Supplier onboarding >>

Based on the Supplier Management Policies and the Supplier Development and Onboarding Management Regulations, we defined the requirements for the development and onboarding of suppliers and conducted a comprehensive assessment of areas such as business information, ethical sourcing, labor management, conflict minerals management, and environmental compliance. Compliance with business ethics, product quality, and safety standards, and labor regulations was a prerequisite for supplier onboarding. We required our core suppliers to obtain certifications for the ISO 9000 quality management system, QC 080000 hazardous substance process management system, ISO 14000 environmental management system, and ISO 45001 occupational health and safety management system. In 2023, we onboarded 165 new suppliers, all of whom have demonstrated a commitment to environmental and social responsibilities without any real or potential significant negative impacts.

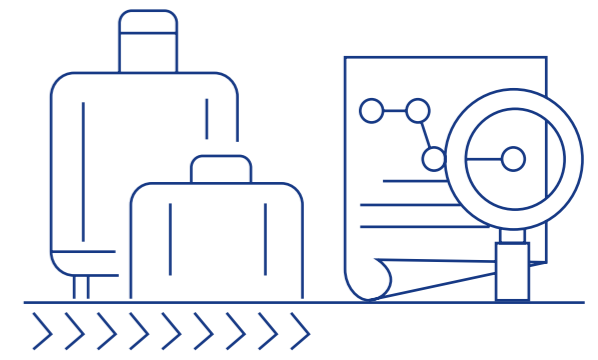

Adhering to the concept of fostering a responsible supply chain, we have underscored ESG responsibility management for our suppliers and have formulated ESG management requirements for suppliers, putting forward responsible management requirements around labor management, business ethics, and conflict minerals management of suppliers.

Ninestar Supply Chain ESG Management Requirements

- Overall requirements:** In accordance with the Supplier Selection, Certification, and Onboarding Procedures, the Supplier Assessment Management Procedure, the Environment, Health and Safety (EHS) Questionnaire and the Social Responsibilities Assessment Form, we assess the labor management and production safety of suppliers in the onboarding process, and also continuously assess indicators such as responsible management in the course of cooperation. We regularly assess suppliers' management of occupational health, safety, and environmental practices, organize supplier self-assessments on various aspects, including child labor, forced labor prohibition, health and safety standards, freedom of association, discrimination prevention, disciplinary measures prevention, business ethics, and wage and hour compliance, and take corrective actions or terminate the supplier relationship in the event of non-compliance with labor, ethics, or other guidelines.
- Hazardous substances control requirements:** In accordance with the HSF Management Procedure and the Suppliers' Conformity Statement of Restricted Use of Hazardous Substances, we require that suppliers with related business must comply with the requirements of the REACH Regulation, RoHS Directive, and the standards for the attestation of Chinese environment mark.
- Business ethics requirements:** In accordance with the Business Ethics Agreement and the Integrity and Self-discipline Agreement, suppliers are required to sign an agreement on integrity, law-abiding and fair competition.
- Supply chain labor management requirements:** We integrate ESG labor management into our supplier audit and assessment processes, prioritizing suppliers' adherence to human rights standards. We mandate suppliers' compliance with the BSCI Code of Conduct and enforce social responsibilities measures, including respecting workers' rights to freely and democratically form trade unions. Additionally, we prohibit suppliers' discrimination against workers based on union membership and ensure their respect for workers' right to collective bargaining. Furthermore, we emphasize suppliers' responsibilities for no discrimination, fair compensation, decent working hours, prohibition of child labor, protection of junior workers, and prevention of forced labor.
- Conflict minerals management requirements:** In accordance with the Declaration of Non-use of Conflict Minerals and the Conformity Statement of Responsible Business Alliance (RBA) Code of Conduct (RBA Conformity Statement), suppliers are required to fulfill their commitment to not use conflict minerals and observe their statement of conformity to the provisions of the RBA Code of Conduct.



Procedure 2: Regular supplier audit and performance assessment >>

In accordance with the Supplier Performance Assessment Management Regulations, we regularly review suppliers and conduct on-site assessments to identify the potential risks of the supply chain and key improvement areas, as well as guide suppliers in enhancing their sustainable management capabilities through performance assessment.

Monthly assessment and regular review:

Based on the Supplier Quality and Performance Assessment Report and the Supplier Regular Review Form, we comprehensively assess suppliers' product quality, delivery, service, and prices and review quality, environmental, and hazardous substance management systems to encourage ongoing improvement among suppliers.

Annual compliance audit:

We revised our supplier scorecard to include labor management, product price and cost, quality management, service quality, and occupational safety and health.

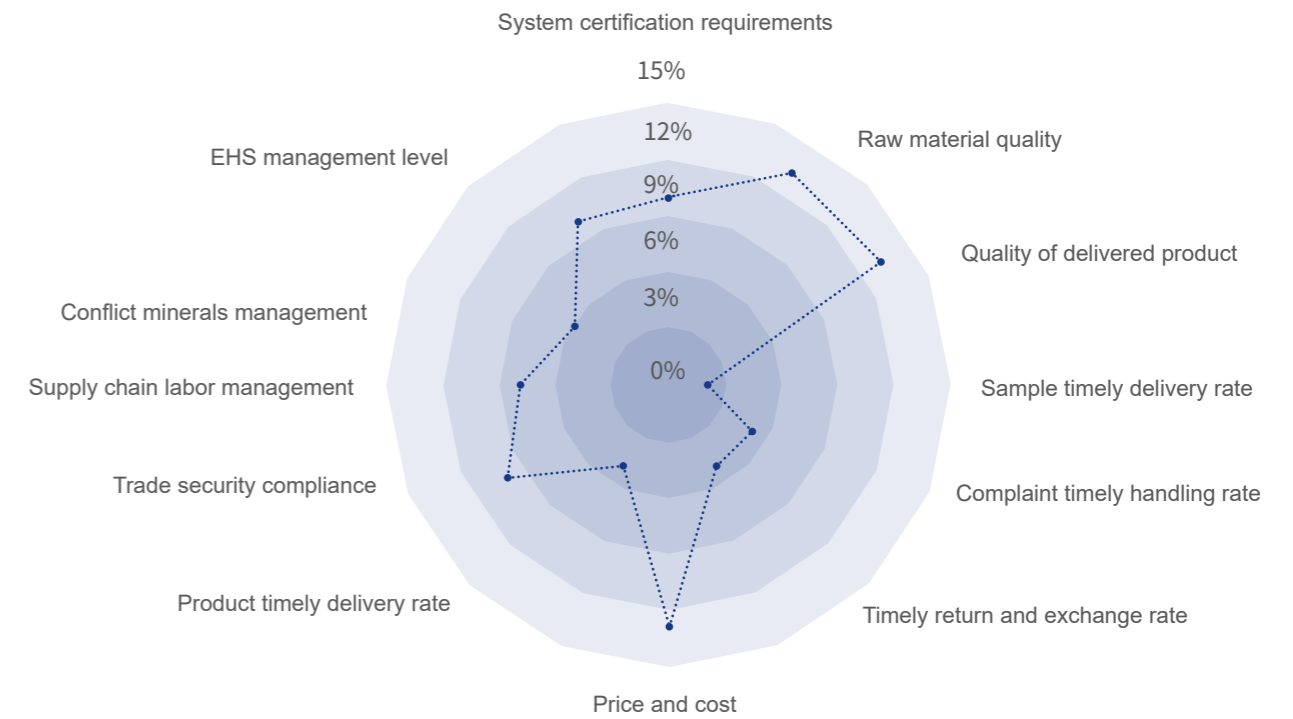

Assessment dimension (Total score: 100)	Weight ratio %	Assessment dimension (Total score: 100)	Weight ratio %
System certification requirements	10	Price and cost	13
Raw material quality	13	Product timely delivery rate	5
Quality of delivered product	13	Trade security compliance	10
Sample timely delivery rate	2	Supply chain labor management	8
Complaint timely handling rate	5	Conflict minerals management	6
Timely return and exchange rate	5	EHS management level	10

We assess all suppliers on the Recognized Supplier List according to the above dimensions and weight, and classify the suppliers according to the assessment results.

Class	Assessment criteria
A	▶ ≥ 90
B	▶ 90 > score ≥ 80
C	▶ 80 > score ≥ 70
D	▶ 70 > score ≥ 60
E	▶ score < 60

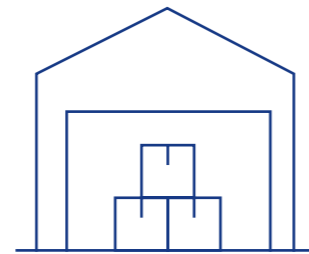

In order to continuously improve our management of suppliers' ESG responsibilities and deepen our focus on sustainable sourcing, in 2023, we extended our supplier management and assessment coverage from Class A (Tier 1) suppliers to Class C (Tier 3) suppliers, incorporated ESG elements into supplier audits, with requirements for environmental safety, social responsibilities, and labor health and safety, and engaged a third party to conduct two external audits. During the Reporting Period, we audited 705 suppliers, a 72% increase compared to the previous year. The audit covered aspects like product quality, labor management, and conflict minerals management. Of these, 61 suppliers were found non-compliant and given a six-month remediation period, during which we assisted them. If they fail to meet requirements after this period, they will be disqualified.

Audit Information of Classes 1, 2 and 3 Suppliers of Ninestar in 2023

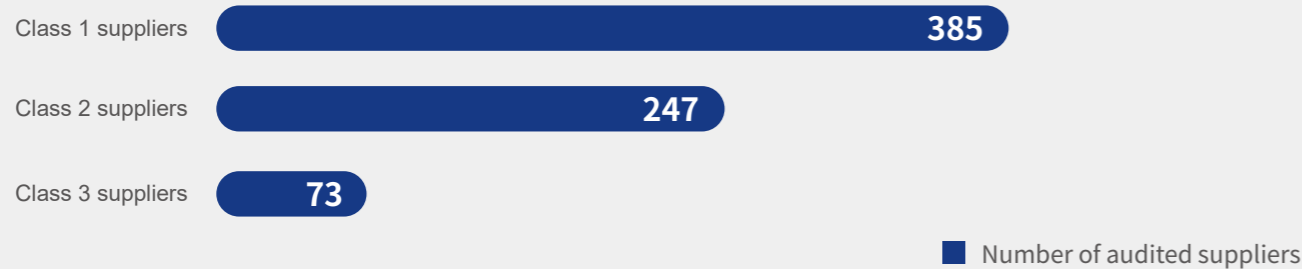

In addition to on-site audits, we also distributed ESG-specific questionnaires to suppliers each year to assess and confirm their performance in environmental protection, anti-corruption, conflict minerals management, and labor management.

Procedure 3: Ex-post remediation for supplier non-compliance >>

To address non-compliance among suppliers identified in the supplier audit, we implement a structured remediation procedure to promote the improvement of our supply chain. First, we engage in detailed communication with the non-compliant supplier, indicating the specific areas of non-compliance and requesting the submission of a remediation plan within a specified time limit. This plan must be concrete, achievable, and include a clear timeline. During the remediation, we provide the necessary support and guidance to help the supplier understand our requirements and achieve compliance. Each supplier is granted two opportunities for remediation. If the supplier still fails to meet our ESG standards after the first remediation attempt, we provide continued guidance. If the supplier still fails to meet the requirements after a second attempt, we will consider terminating the supplier relationship.

Among the suppliers audited in 2023, 61 failed, mainly due to the following problems. In response, we promoted active management and promptly urged suppliers to make improvements in an orderly manner.

Main problems identified	Supplier improvement results
Supplier labor occupational health management	<p>Some suppliers lacked ISO45001 certification or had not renewed it, indicating their insufficient attention to occupational safety and health.</p> <ul style="list-style-type: none"> Define the management requirements for suppliers' labor health and safety according to the supplier ESG management requirements Strengthen training for suppliers
Working hours of suppliers' employees	<p>Some suppliers have employees who work long overtime hours (also a common problem in the industry) and have fewer days off. While this overtime work is largely voluntary, we recognize that such non-compliance can have adverse societal effects.</p> <ul style="list-style-type: none"> Define the requirements for working hours according to the supplier ESG management requirements, and record the total working hours and number of days off for employees. Strengthen training for suppliers Reach an agreement with the supplier concerned to remedy the problem in order to reduce the negative impact on society
Supplier integrity management	<p>One case of corruption was identified in the audit and referred to the judicial authorities.</p> <ul style="list-style-type: none"> Define the business ethics requirements for suppliers according to the supplier ESG management requirements Conduct regular supplier ethics training Improve the internal business ethics management structure and risk management Sign the Integrity and Self-discipline Agreement of suppliers
Conflict minerals management	<p>Suppliers fail to adequately manage their downstream partners, resulting in incomplete or untimely feedback on the research questionnaire.</p> <ul style="list-style-type: none"> Define the relevant requirements according to the supplier ESG management requirements Strengthen training for suppliers
Product delivery quality	<p>The quality of some suppliers' products fails to meet our product quality standards.</p> <ul style="list-style-type: none"> Identify the causes Provide a six-month remediation period and assist in the remediation, and disqualify the suppliers that fail to complete the remediation within the period.
Product delivery time	<p>Some suppliers delay delivery due to a number of factors.</p> <ul style="list-style-type: none"> Identify the causes Provide a six-month remediation period and assist in the remediation, and disqualify the suppliers that fail to complete the remediation within the period.

Procedure 4: Supplier exit >>

For suppliers that do not comply with the codes of conduct, we impose penalties such as warnings and notifications or immediate termination of cooperation, depending on the severity of the case, as well as fines and other appropriate penalties. During the Reporting Period, 61 suppliers failed the audit, but they are currently in the remediation period and their cooperation has not been terminated for the time being.

7.1.3.2 Optimize supplier incentive policies

We build long-term, stable relationships with our suppliers, recognizing the high quality of their services and products and inspiring them to maintain high standards consistently. According to the Supplier Development and Management Procedure, we provide a series of incentives for suppliers rated A in the previous year. These incentives include but are not limited to offering extended contract durations and providing preferential procurement opportunities.

We also acknowledge suppliers exhibiting exceptional ESG performance. The top-ranked supplier in the annual assessment receives an "Excellent Supplier" plaque as a public acknowledgment of its outstanding ESG performance. Additionally, we tailor the assessment criteria and weight for ESG labor management and conflict minerals management according to the scale and scope of operations of our suppliers. We plan to progressively increase the weight of these factors in the future to ensure that our supply chain meets higher standards in terms of human rights and environmental protection.

At the same time, we acknowledge the necessity of implementing both incentives and supervision to motivate suppliers to better fulfill their ESG responsibilities. For incentives, we conduct regular supplier assessments and present accolades such as "Best Supplier" to encourage improved ESG performance among our suppliers. For supervision, we enforce a demerit point system for suppliers failing to meet ESG standards. For instance, breaches in labor management result in demerit points in the supplier assessment. This helps ensure suppliers' compliance with ESG requirements.

7.1.3.3 Supply chain integrity management

Effective supplier integrity management ensures the legality and compliance of our business dealings with suppliers, fosters a fair competitive environment, prevents bribery and undue benefits transfer, and supports the sustainable growth of our suppliers. Moreover, reinforcing integrity within our supply chain is integral to our Company Culture, instilling values of transparency and integrity among our employees and elevating our ethical standards.

<p>Make clear the standard</p> <p>Business ethics requirements for suppliers are defined in our supplier ESG management requirements.</p> <p>The Business Ethics and Integrity Control Procedures explicitly states that employees are prohibited from soliciting or accepting money, goods, or any form of gifts from suppliers in any name. Likewise, suppliers are required not to offer gifts, goods, negotiable securities, or resort to any other covert means of providing undue benefits to any Ninestar employee, whether directly or indirectly, in private.</p> 	<p>Conduct audits regularly</p> <p>We conduct regular ESG audits and questionnaire surveys of our suppliers, promptly identifying and addressing any ethical risk. For suppliers found to have integrity risks, we implement proactive management, providing them with a six-month remediation period. Failure to complete the remediation within this time limit will result in disqualification from our supplier list.</p> 
<p>Make integrity commitment</p> <p>In accordance with Ninestar's regulations suppliers are required to sign the Integrity and Self-discipline Agreement, and the signing rate was 100% during the Reporting Period.</p> 	<p>Strengthen training</p> <p>We conduct regular training on business ethics management for suppliers to foster the concept of integrity.</p> 

7.1.3.4 Supply chain conflict minerals management

We are fully aware of the potential for significant adverse impacts related to the mining, transportation, trading, processing, or export of minerals from conflict-affected and high-risk areas and we recognize our corporate responsibility in upholding human rights and avoiding any adverse societal impacts.

We comply with domestic and international laws and guidelines such as the Chinese Due Diligence Guidelines for Responsible Mineral Supply Chains, the OECD Due Diligence Guidance for Responsible Supply Chains of Minerals from Conflict-Affected and High-Risk Areas, and the Dodd-Frank Wall Street Reform and Consumer Protection Act, and are committed to adopting the requirements on conflict minerals therein. We formulated an internal policy titled Due Diligence Management Policies for Responsible Mineral Resource Supply Chains and publicly disclosed it on the official website. Besides, we incorporated it into the contracts with mineral resource suppliers and revised the internal procurement policy to include the conflict minerals management. This policy applies to Ninestar and its subsidiaries' mineral supply chains, encompassing tungsten, tin, tantalum, gold, nickel, cobalt, manganese, lithium, graphite, mica, copper, and aluminum, and stipulates the following provisions:

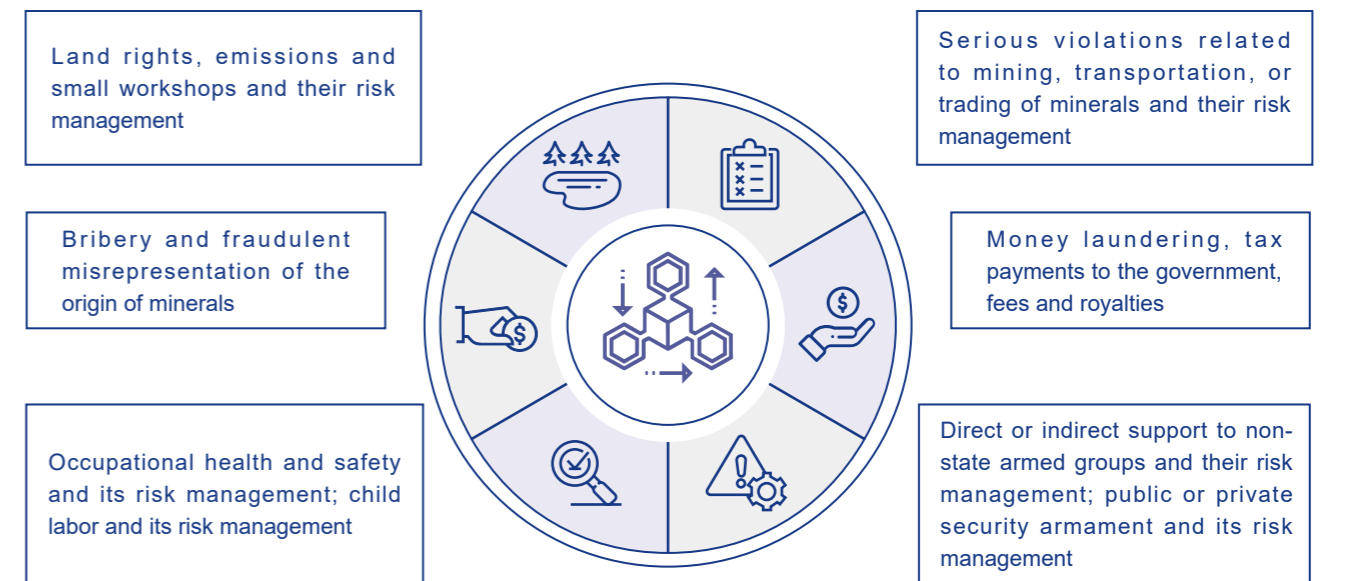

We take the Due Diligence Management Policies for Responsible Mineral Resource Supply Chains as the basic standard for promoting the management of supply chain conflict minerals. At the same time, our subsidiaries establish their own applicable conflict minerals management policies in accordance with the Dodd-Frank Act's final rule on conflict minerals management and conduct management of supply chain conflict minerals on an annual basis in a variety of applicable ways to effectively identify and trace the source of conflict minerals raw materials and ensure the legality of the source of the raw materials.

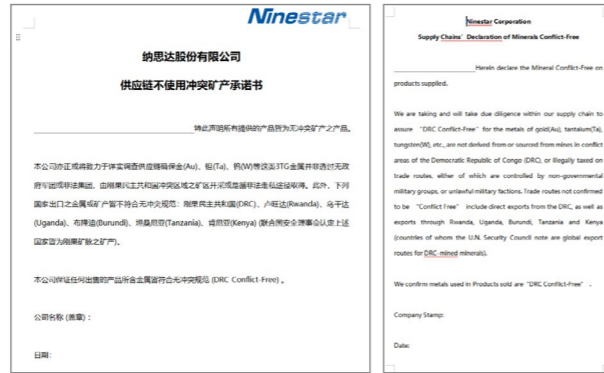

In 2023, we completed the conflict minerals reporting templates (CMRT) for a total of 418 suppliers, 90% of which have signed a Commitment To Not Use Conflict Minerals in the Supply Chain with us, while a total of 341 suppliers cooperated in completing conflict minerals audits, resulting in a completion rate of over 80%.

For suppliers who are unable to cooperate with us in completing conflict minerals audits, we will take the following steps:

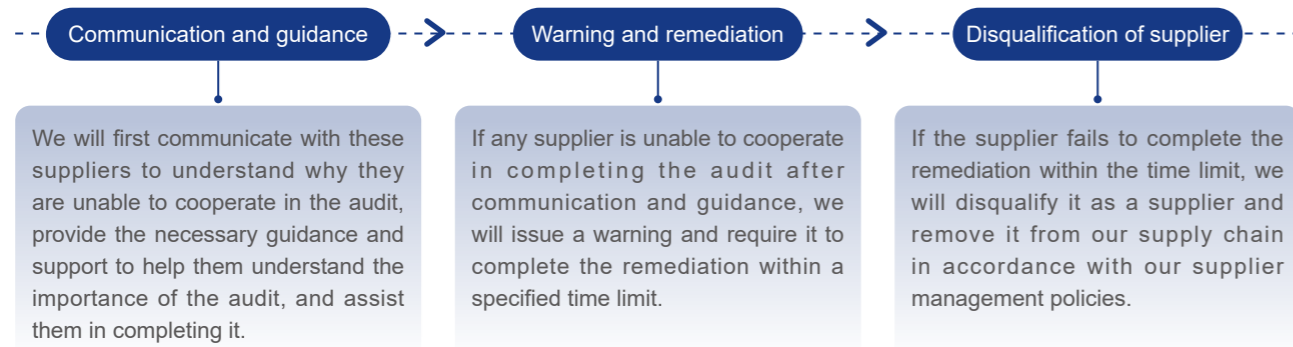

We have taken various measures to gradually expand the audit coverage and intensity of conflict minerals, such as increasing audit staff, optimizing the audit procedure, and enhancing supplier training on conflict minerals management in order to strengthen our ability to manage conflict minerals in the overall supply chain and to reduce operational risks. During the Reporting Period, we conducted 133 supplier training sessions on topics including labor management and conflict minerals management.



7.1.3.5 Conflict minerals management capacity building

We build our conflict minerals management capacity from two perspectives: internal management and external management.

Internal management	External management
<ul style="list-style-type: none"> Analyze leading peer practices, improve the conflict mineral policy system to cover the procurement and use of raw materials from areas of conflict minerals, and meet customer requirements. Study and select the working methods and procedures related to conflict minerals and put them into practice to improve conflict minerals management. Deepen indicator management on the basis of the focus points of assessment and increase the transparency of disclosure. Develop a publicized conflict minerals management policies and a declaration of non-application to conflict minerals. Conduct due diligence on suppliers' conflict minerals commitments to avoid the use of controversial materials. Set quantitative targets for the purchase of controversial materials. Engage an external agency to conduct third-party conflict minerals certification. Develop due diligence and material traceability plans for supply chain conflict minerals and make clear the public disclosure of investigation results based on the OECD Due Diligence Guidance for Responsible Supply Chains of Minerals. 	<ul style="list-style-type: none"> Clear objectives: We plan to achieve a 100% signing rate of the Commitment To Not Use Conflict Minerals in the Supply Chain by 2025 for all suppliers with whom we have major business dealings. Traceability management: We require relevant suppliers to sort out and provide proof of the origin of the materials supplied, communicate with upstream suppliers in the supply chain, and work together to ensure that the materials purchased can be traced back to at least the smelting plant to ensure that the metal raw materials purchased originate from non-conflict mineral smelting plants and to strengthen the capacity of traceability management of conflict minerals. Encouragement and supervision: We encourage and supervise suppliers to formulate and implement internal policies on conflict minerals management and to increase the transparency of information. Empowerment training: We have already delivered conflict minerals-related training to key suppliers and intend to expand this training to all suppliers online or offline.

7.1.4 Indicators and objectives

Objectives	Progress
Distribute questionnaires on social responsibilities to suppliers every year	Supplier audit: 705 suppliers
Conduct regular quality improvement training for all suppliers every year	The response rate of conflict minerals survey: 81.48% (341/418)
By 2025, 100% of suppliers of major business dealings will need to sign the Commitment To Not Use Conflict Minerals in the Supply Chain	Supplier training: 133 training sessions with 329 participants



7.2 Employees' Rights, Interests, Diversity and Equity

7.2.1 Concept

We recognize that employees are the cornerstone of Ninestar's development and are committed to constructing an inclusive, equitable, and collaborative work environment. By attracting and nurturing exceptional talent, we encourage employees from diverse backgrounds with varied experiences to unleash their wisdom and creativity. We aim to provide each employee with a humane workplace, open channels of communication, and competitive salary and benefits, comprehensively safeguarding their legitimate rights and interests.

To foster a welcoming work environment, we continuously optimize our employee care system, addressing employees' concerns and needs in both work and life, effectively enhancing their job satisfaction and sense of belonging. Through diverse cultural and recreational activities, we enrich employees' leisure time, guiding them to pursue a better quality of life and achieve harmony between work and life.

7.2.2 Strategies

We adhere to the respect and compliance of laws, consistently adhering to relevant national laws and regulations such as the Labor Law of the People's Republic of China, the Civil Code of the People's Republic of China, and the Social Insurance Law of the People's Republic of China. Moreover, we strictly adhere to applicable laws and regulations in the locations where we operate. We actively refer to international standards, including the Universal Declaration of Human Rights, the Convention Concerning Forced or Compulsory Labor, the Minimum Age Convention, the RBA Code of Conduct, and the BSCI Code of Conduct, and we are committed to upholding and safeguarding the legitimate rights and interests of our employees.

We uphold the principle of being people-oriented, strictly prohibiting the employment of child labor and opposing any form of forced labor. Through these measures, we are dedicated to providing all employees with a fair, safe, and respectful working environment, ensuring that the legitimate rights and interests of each employee are fully protected while promoting our sustainable development and fulfillment of social responsibilities.

We have established a mechanism for labor employment review and supervision, conducting audits at various stages, such as new employee recruitment and daily human resource management to prevent and control related risks, as well as conducting irregular self-inspections and checks.

7.2.3.2 Ninestar complies with the labor rules stated by the BSCI Code of Conduct

	Freedom of association and right of collective bargaining	• Respect the workers' right to set up the trade union in a free and democratic manner and to participate in the bargaining
	No discrimination	• Provide equal opportunities, and don't discriminate against any worker
	Fair remuneration	• Respect the workers' right to get fair remuneration
	Decent working hours	• Comply with the regulations on working hours
	Occupational health and safety	• Ensure a healthy and safe labor environment, assess risks and take all necessary measures to eliminate and reduce risks
	No employment of child labor	• Don't employ any worker under the legal working age
	Protect junior workers	• Provide junior workers with special protection
	No employment without a guarantee	• Formulate labor contracts and employ workers in accordance with legal provisions
	No forced labor	• No bondage, human trafficking or involuntary labor in any form

7.2.3 Actions and practices

7.2.3.1 Democratic communication by employees

We respect employees' freedom of association and expression, allowing and respecting employees to freely associate and engage in collective bargaining under the premise of complying with local laws and regulations. We implement a constructive bidirectional communication mechanism, emphasizing the role of employee democratic management, participation, and supervision. We have established a reasonable suggestions office and an anonymous grievance channel, providing employees with diverse democratic communication platforms to ensure their right to information, participation, and supervision in corporate management.

We have established a federation of trade unions as an effective channel for communication between employees and the Company, with over 8,900 existing union members. Moreover, we understand and respond to employee appeals through various means, such as the congress of workers and staff, the reasonable suggestions office, and interviews with employees.



Ninestar's democratic communication and employee survey mechanism

Reasonable suggestions



- We have placed anonymous reasonable suggestions and anti-corruption reporting notice boards in crowded areas, advocating democratic communication and anti-corruption reporting across the Company.
- All employees can anonymously or openly lodge complaints or suggestions regarding personal work and life issues and various aspects of the company through channels such as phone calls, suggestion boxes, DingTalk, and email on a legal and compliant basis.
- The Human Resources Department promptly follows up on employee complaints and suggestions, categorizes and forwards them after verification, and relevant departments provide feedback or solutions to the reasonable suggestions office within five working days through email or written form.

- We conduct internal management surveys through methods such as Gallup Q12 employee questionnaires and DingTalk platform surveys, covering aspects such as job satisfaction, team atmosphere, learning, and growth.
- Based on the feedback and analysis of the surveys, the Human Resources Department formulates and implements improvement plans to enhance employee dedication, increase team cohesion, and optimize work processes.
- We ensure that employees have full rights in corporate governance, achieving democratic management within the Company.

Internal management surveys



Work environment satisfaction surveys



- Every quarter, we conduct anonymous work environment satisfaction surveys for employees in three dimensions: workplace, company canteen, and employee dormitories.
- In 2023, we received a total of 11,474 anonymous feedback responses, with satisfaction rates as follows:
 - Workplace property satisfaction: 95.8%
 - Dormitory satisfaction: 97.06%
 - Canteen satisfaction: 92.48%
- Based on the survey feedback, we identified 78 items for improvement. By December 2023, 54 improvement items had been completed, and 24 were in progress.



On April 25, 2023, the headquarters' Human Resources Department established the reasonable suggestions office. During the Reporting Period, a total of 105 employee reasonable appeals were received, and the Human Resources Department was responsible for following up and resolving them.

Ninestar's anonymous reasonable suggestion and anti-corruption reporting notice boards

7.2.3.2 Diverse employee groups

Employees are the most valuable asset of the Company, driving continuous development and innovation. A diverse and vibrant talent team is crucial to the success of an enterprise. Therefore, we are steadfast in our commitment to building an inclusive and diverse work environment that promotes mutual respect and understanding among employees and inspires innovative thinking and new approaches to problem-solving. We recognize that employees' diverse backgrounds are essential sources of innovation and competitiveness for the Company. Hence, we proactively take measures to attract outstanding talents from different cultures, genders, age groups, and professional backgrounds, bringing broader perspectives and deeper insights to our enterprise.

Total number of employees 21,997

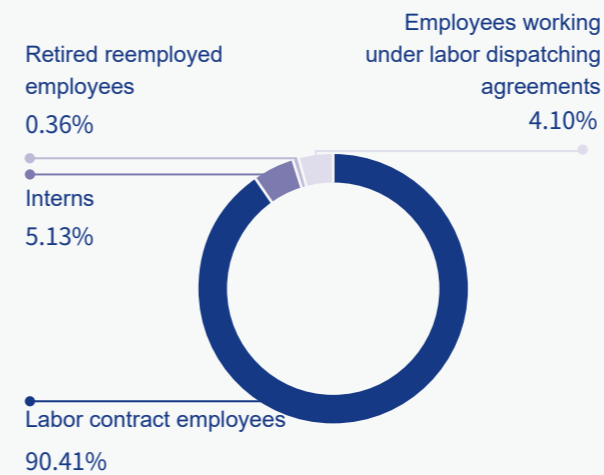

By gender⁵

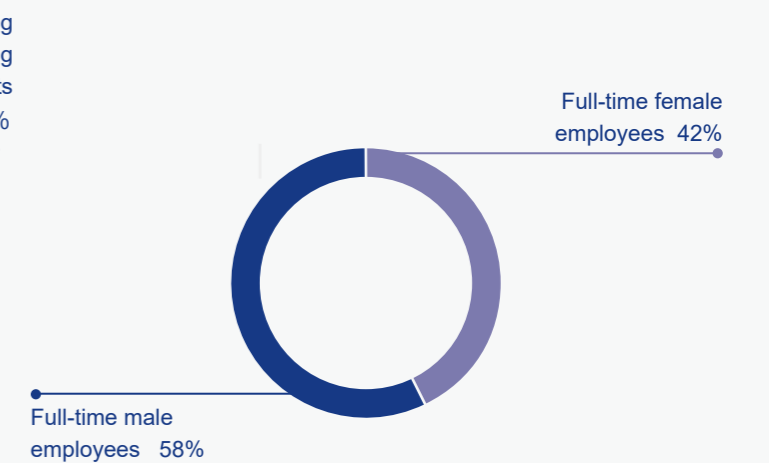

By age

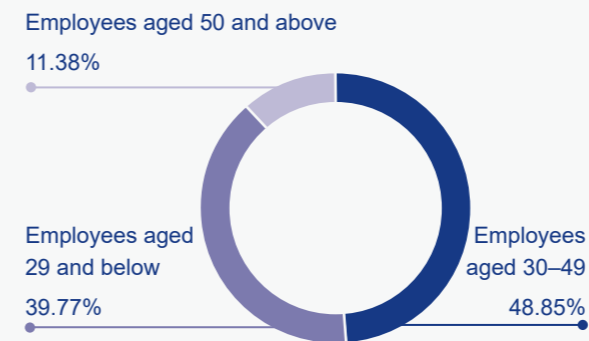

By educational qualification

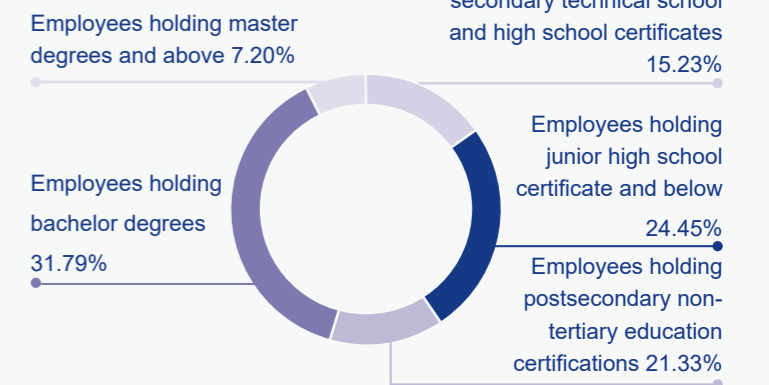

By profession

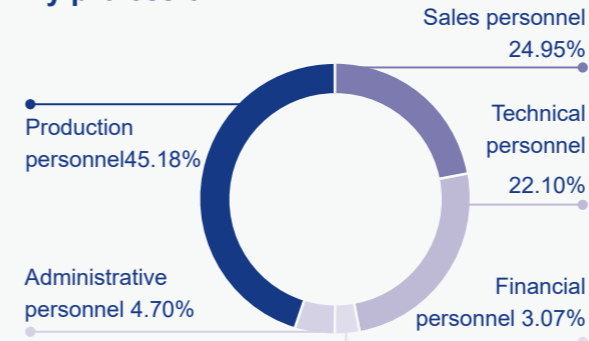

By geographical region

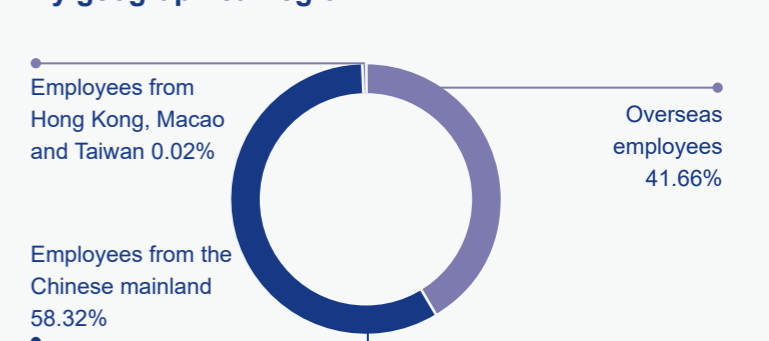

⁵The statistics on employees of some of our overseas subsidiaries by gender are unavailable due to the restriction of their local laws and regulations.

7.2.3.3 Employee diversity and inclusion

We have formulated and implemented the Ninestar Guarantee System for Employee Diversification, Rights and Interests, welcoming talent from all walks of life and formulating talent strategies and labor diversity plans in line with our business development strategy. We actively develop new talent pools, implement fair and compliant recruitment management, and support labor diversity. We supervise and implement the performance of talent diversity as an assessment indicator, incorporated into the senior management assessment of our Human Resources Department. Additionally, we attach importance to the construction of corporate diversity culture, regularly conducting labor diversity training for all employees (including full-time and part-time staff) and outsourcing service providers.

During the Reporting Period, we conducted the following work to strengthen employee diversity, equality, and inclusion:

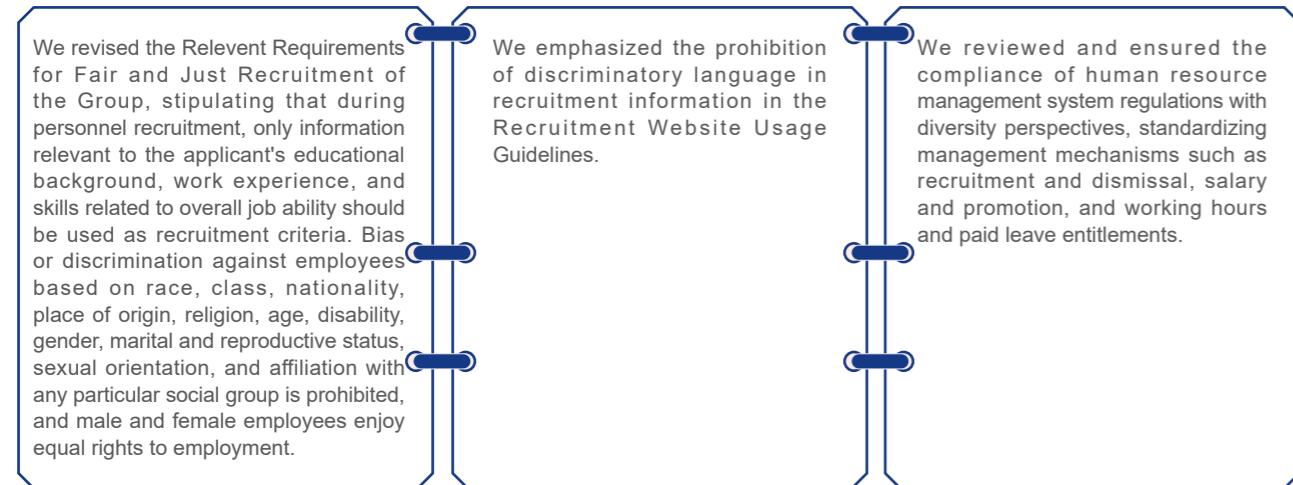

7.2.3.4 Protecting employees' rights and interests

Based on international standards such as the UN Guiding Principles on Business and Human Rights and the Universal Declaration of Human Rights (UDHR) approved by the United Nations Human Rights Council, the International Labor Organization's Declaration on Fundamental Principles and Rights at Work, and the UN Global Compact Ten Principles (UNG), as well as relevant regulations in various regions, we take actions consistent with the RBA Code of Conduct to ensure compliance with human rights commitments when conducting global operations. We maintain a fair and transparent recruitment process, respect employees' legitimate rights and interests, eliminate forced labor, and provide fair and reasonable salaries to all employees, ensuring their health and safety, caring for their well-being, and strengthening the protection of employee rights and interests.

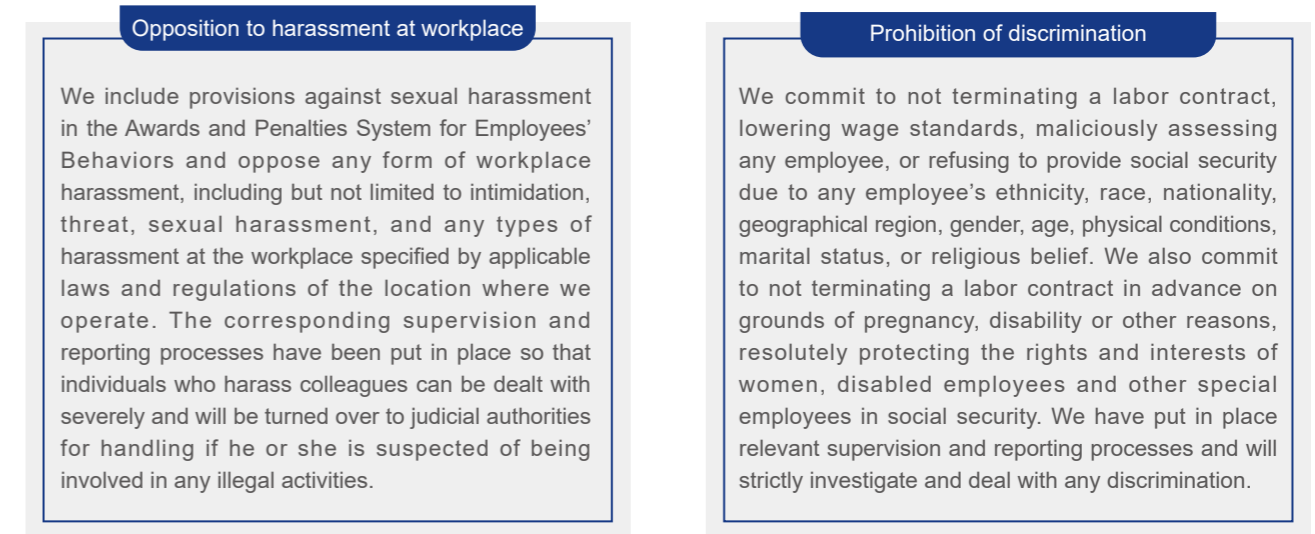
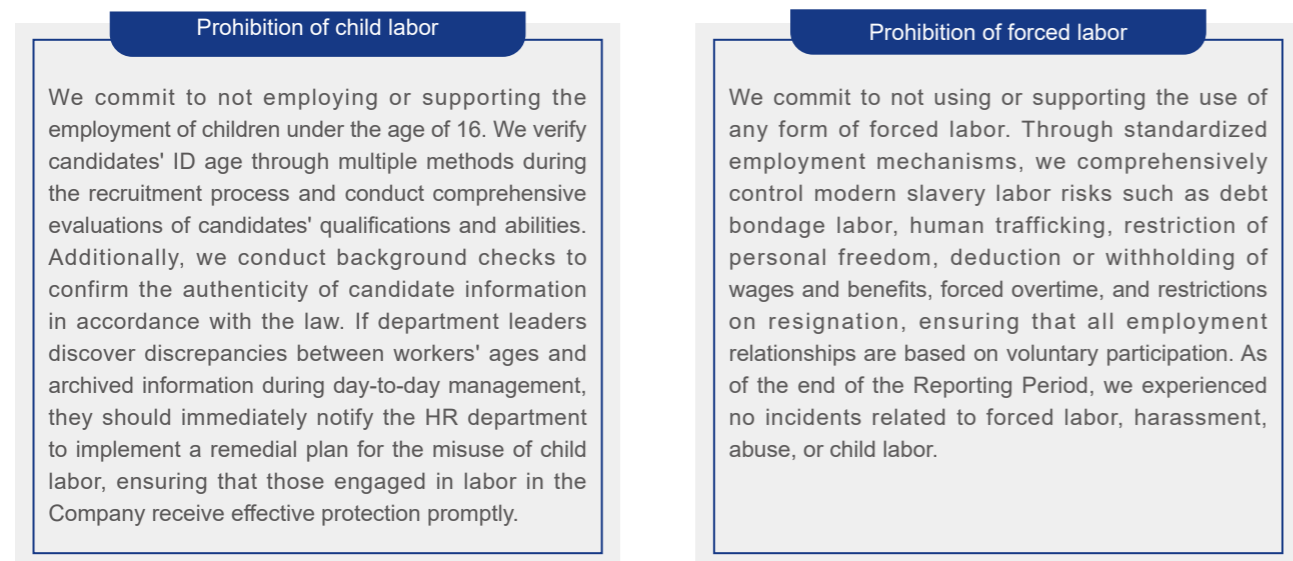

During the Reporting Period, we comprehensively reviewed and revised the salary management system and detailed rules, forming a new Comprehensive Salary Management System to further optimize and improve our salary system, ensuring its consistency with our development strategy and market positioning.

In this revision, we emphasized the structured design and updates of short-term and long-term incentive mechanisms, strengthening incentives for employees demonstrating outstanding capabilities and performance. With "performance-oriented" as the core concept, we fairly determine employees' salary levels, bonuses, and other benefits to attract, retain, and motivate our core employees. We updated the salary schemes for director-level management personnel, ensuring that their performance is closely linked to the group's overall organization performance and profit completion rate, not only enhancing the management's enthusiasm and sense of responsibility but also further promoting the achievement of our overall strategic goals.



To facilitate the achievement of our overall operational goals and fully leverage the role of performance management in realizing our strategies and enhancing employee capabilities, we conduct monthly, quarterly, semi-annual, and annual performance assessments for all employees and take the key performance indexes (KPIs), key target indexes (KTIs) and daily work goal attainment as the assessment bases. The assessment results are divided into five levels (A, A-, B, B-, C). Based on the assessment results, we promptly communicate with employees, propose improvement directions and measures, and follow up on performance enhancements. Additionally, we provide employees with channels for appeals, including email and phone. If employees have objections to the performance assessment results, they can appeal and request a review from the final reviewer or the Human Resources Department.

7.2.3.5 Employee benefits and pay

We strictly adhere to national and local social security mechanisms and are committed to improving employee benefits and pay. We provide practical good benefits to pay, encompassing all staff, and promise that such benefits and pay will not be affected due to employees' ethnicity, race, nationality, geographical region, gender, age, physical conditions, marital status, religious belief or other factors.

We offer a comprehensive benefit protection system for employees as follows:



Providing Affordable Housing

On June 30, 2023, after two years of construction, the affordable housing project, Phase 1 of the Ninestar Haina Garden, consisting of 229 fully furnished units, was delivered as scheduled. The units range from 2 to 4 rooms, with a floor area of 70-110 square meters. Ninestar employees have the opportunity to purchase talent-secured housing at significantly below-market cost. Haina Garden is located less than 2 kilometers from our Pingsha Park, with well-developed surrounding facilities, facilitating a more convenient lifestyle and work environment for employees working in Pingsha, thus realizing the vision of comfortable living and career fulfillment.



Providing Affordable and Quality Dormitories

In terms of employee accommodation, we offer convenient dormitories to ensure employees have access to affordable housing. Investing resources, we have designed independent single rooms to fully meet employees' need for personal space, ensuring a good balance between work and life. To better care for employees' well-being and alleviate their financial burden, we have introduced employee dormitory rental benefits, providing stable and economically viable living environments for employees at a monthly rent not exceeding CNY700, significantly lower than market rental prices. This reflects our concern and support for employees' living conditions, alleviating their financial stress and enabling them to work with peace of mind, unleash their full potential, and achieve mutual development.



7.2.3.6 Employee cultural development

We are committed to creating a comfortable working environment for employees, fostering a warm work atmosphere, and placing importance on the humane care of employees' physical and mental health, work-life balance, and work experience. By deeply engaging in service site construction, establishing a warm home for employees, and strengthening employee care, we ensure that employees truly feel the warmth of home.

Festival party culture

During festivals such as the Spring Festival, Lantern Festival, Children's Day, Mid-Autumn Festival, Women's Day, Mother's Day, Father's Day, Teacher's Day, Thanksgiving, and Christmas, various departments organize a range of online and offline festive activities to create a jovial festive atmosphere for different groups and foreign employees. Departments regularly hold themed birthday parties, allowing employees to feel cared for through games, cake sharing, lucky draws, and other activities.

Thanksgiving activities

We hold Thanksgiving activities every year to express gratitude for employees' hard work and contributions over the past year. By organizing a wide variety of entertainment activities such as literary performances, lottery draws, and feasts, outstanding employees are commended and rewarded, enhancing their sense of belonging and participation.



Christmas activities

Respecting the diverse cultures of employees worldwide, our overseas offices hold a series of Christmas celebration activities every year, such as Christmas tree decoration, singing Christmas carols, and gift exchanges, providing employees with holiday arrangements so they can spend more time with their families and friends during the festive season.



Engineer's Day

Based on our talent structure and business priorities, Engineer's Day was established by Ninestar to acknowledge and commend the outstanding contributions of the engineering team to our technological innovation and development. Our Engineer's Day is held annually on October 24. On this day, we extend holiday greetings and blessings to all engineers, expressing recognition for their professionalism and hard work. Through various activities such as the "How Much Do You Know About Values" treasure hunt, the engineering team's recognition of research and development innovation is stimulated, team cohesion is enhanced, and employees gain a deeper understanding of our culture and values in a relaxed and pleasant atmosphere.



Women's Day

Female employees play an indispensable role in driving our development and innovation. Therefore, we are committed to creating a workplace culture that respects and supports women's professional growth. Through the celebration of Women's Day, we not only express respect and appreciation to female employees but also enhance their confidence and unleash their professional potential through a series of carefully planned activities. We firmly believe that by creating a supportive environment for women's professional growth, we can better unleash the potential and creativity of female employees, laying a solid foundation for our long-term success and sustainable development. We look forward to working with all female employees to create a more equal, respectful, and vibrant workplace together.



Mid-Autumn Festival party

On September 26, 2023, we held Mid-Autumn Festival celebrations online through livestream and via offline interactive formats. The Nanping Park and Pingsha Park simultaneously hosted excellent programs to convey a festive atmosphere, wishing for family happiness and reunion.



Union culture development

We understand the importance of union culture development in enhancing employee cohesion and Company Culture. Therefore, we are committed to establishing and improving internal union-related systems to ensure that union activities and work are carried out in accordance with laws and regulations, effectively safeguarding the rights and interests of employees.

Our union purchases gifts, souvenirs, and commemorative items for employees during festivals to express care and blessings. To promote union culture development, we allocate hundreds of thousands of CNY in special funds each year to support various cultural activities organized by the union, such as literary performances, sports competitions, and activities, aiming to enhance unity and friendship among employees through diverse activity formats, promote individual growth and teamwork, and boost positive energy.

Care for women culture

We are committed to providing every female employee with the most intimate care in their daily work. This year, we continue to renovate and maintain special rooms for mothers that are equipped with multi-functional areas such as nursing areas and public rest areas. We also provide sofas, folding nap beds, refrigerators, disinfection cabinets, microwaves, breastfeeding supplies, and mother and baby bookshelves for working mothers. This effectively safeguards the legitimate rights and interests of female workers and promotes the construction of family-friendly workplaces. We also organize qipao classes and other activities.



Advocate sports culture

We actively promote the construction of interest groups, establish six interest associations, including the Dance Association, Badminton Association, Football Association, Music Association, Board Game Association, and Business Etiquette Association, increase incentive mechanisms, and further enrich the circle of staff friends and leisure cultural life. Badminton courts, basketball courts, table tennis rooms, billiards rooms, dance rooms, yoga rooms, etc., are set up in the Nanping Park and Pingsha Park for sports activities. Various departments, interest groups, etc., regularly organize various competitions, enriching employees' leisure activities and enhancing their sense of belonging.



7.2.4 Indicators and objectives

Objectives

- Facilitate democratic communication and employee feedback channels
- Promote workplace diversity and inclusion, and strengthen employee rights and interests protection
- Gradually standardize the human resources management system of overseas subsidiaries: take into account the legal requirements of various countries, respect cultural and habitual differences, realize the localization revision and implementation of necessary regulations, and streamline personnel-related processes and approval authority
- Continuously optimize social recruitment management processes: through talent assessment, interviewer training and certification, etc., more accurately screen and identify talents that meet our requirements
- Provide richer employee benefits: strengthen employee care, provide customized benefits

Progress

- Created a diverse and equal workplace culture; increased the number of female managers to 193.
- Revised the Relevant Requirements for Fair and Just Recruitment of the Group, emphasizing the prohibition of discriminatory language in recruitment information
- Formulated the Comprehensive Salary Management System, comprehensively reviewed and revised the salary management system and detailed rules, enhancing the incentive intensity for high-capacity, high-performance employees
- Delivered our affordable housing to employees, providing housing benefits
- Provided employees with diverse company activities and benefits, distributing holiday bonuses and gifts to employees during traditional festivals, and strengthening employee care



7.3 Human Capital Development

7.3.1 Concept

We know that talent is a fundamental resource that we need to make progress. Therefore, we consider promoting the comprehensive development of employees to be one of our key development objectives. We value their personal growth and their career development planning. By establishing a comprehensive training system and free-to-access career development channels, we ensure that their potential can be given full play during the creation of our corporate value and that their career development paths will be clearly revealed. We provide support and incentives for employees' pursuit of further education and aid their skill learning and comprehensive quality development so that employees can grow with us and work with us to promote our continuous development and assumption of social responsibilities.

7.3.2 Strategies

We attach great importance to talent training and development. With a view to effectively improving our employees' professional proficiency, we have built a scientific mechanism for talent team building. By formulating administrative provisions on training such as the Training Management System, the Administrative Provisions on the Internal Lecturers, the Administrative Provisions on the Campus Recruitment of Fresh Graduates, the Administrative Provisions on the Pre-service Training of Socially Recruited Employees, the Administrative Provisions on the Pre-service Training of Employees, and the In-service Degree Education Management System, and building an internally comprehensive training system that is formed of the training course system, the training organization and implementation system, the training evaluation system, the training lecturer system, and the training budget system, we create a good internal learning environment for employees, provide them with free-to-access channels of career development and promotion mechanisms, and support their continuous progress and career development.

7.3.3 Actions and practices

7.3.3.1 Talent recruitment

We attach great importance to the independent selection and training of talent by formulating the Strategy for Building a Diverse Talent Pipeline and annually preparing campus recruitment plans. While global new graduates are openly recruited to empower our technological reform and business development with fresh blood, talent pooling programs such as the management trainee program are regularly carried out and special training schemes for new graduates are prepared. Currently, 20% of the members of our management and employees at higher levels were recruited via campus recruitment. The number of employees to be recruited via campus recruitment every year stably remains at approximately 200, accounting for 20% of our annual target of talent recruitment and leaving the other 80% for social recruitment.

Moreover, in order to expand recruitment channels and make employees more enthusiastic about internal referrals, we have formulated the Incentive Plan for Internal Referrals by Employees while encouraging on-the-job employees to refer proper candidates to us and setting special rewards for internal referrals.

The Strategy for Building a Diverse Talent Pipeline is implemented by means as follows:



7.3.3.2 Deepened industry-university-research cooperation

We continuously explore and implement diverse measures for talent introduction and training. Through industry-university-research cooperation, we have established close partnerships with higher educational institutions, based on which we cooperate to develop differentiated mechanisms for university-enterprise cooperation and facilitate the exchange and cooperation between both parties in terms of technology and talent. Industry-university-research cooperation is a win-win for both parties, as it not only brings us new blood with potential but also brings students opportunities for practice and growth. We believe that we will gain a long-term advantage in talent from this deepened mode of industry-university-research cooperation, which will also serve as a solid pillar that supports our continuous development and innovation.

We never stop exploring diverse approaches to talent pooling and have formulated differentiated mechanisms for university-enterprise cooperation. We also actively enter into partnerships with more institutions that share our vision and aspire to long-term development. Currently, we have concluded agreements with twenty regular higher education institutions (HEIs), such as the Jiangxi University of Science and Technology, the University of South China, and Hunan University of Technology. Our university-enterprise cooperation has been customized and new modes besides traditional fall and spring campus recruitment periods exist to strengthen our exchange with these HEIs in terms of technology and talent.

We provide intern orientation and direct access to real projects for new graduates during their internships, helping them better understand our business status and more rapidly change their perceptions of their identity and roles into the right ones. Meanwhile, we give official offers to interns with excellent performance and developmental potential or convert their internships into full-time roles. In 2023, in active response to the government's policy on promoting the development of the Guangdong-Hong Kong-Macao Greater Bay Area into a hub of high-quality talent, we took the initiative to provide a number of internship offers in Zhuhai's Outstanding Young Talents Program (Overseas) for 2023, a collaboration effort between the government and enterprises. These offers were granted to interns from famous universities in the UK, the US, Hong Kong, and Macao, who also gained valuable on-the-job learning experience through industrial park tours, production line visits, and post-practice presentations on real projects.



One of our focuses has been placed on providing overall solutions for the co-building of the discipline of 3D printing as a support for the implementation of relevant professional education standards and relevant talent training plans. We not only provide course resources and professional equipment but also send experts to participate in course development, optimization, and iteration for disciplines co-built by universities and us and create featured practical training courses on 3D printing. During the Reporting Period, we maintained good relationships with vocational schools and technician schools in Zunyi City, as we were co-building the disciplines of 3D printing and laser printing with Fenggang Secondary Vocational and Technical School and Wuchuan Secondary Vocational School, as well as the discipline of e-commerce with Zunyi Vocational and Technical College and the discipline of computer science with Chishui Secondary Vocational School.

We attach great importance to the specialized knowledge and comprehensive quality of students from our partner schools, which is why we provide bonuses for skill contests and other relevant events and send backbone technicians to offer guidance. We will give internship offers and full-time offers in advance to students with excellent performance in these activities. Additionally, we have participated in modern apprentice training by regularly sending lecturers to provide professional and vocational planning and guidance services.

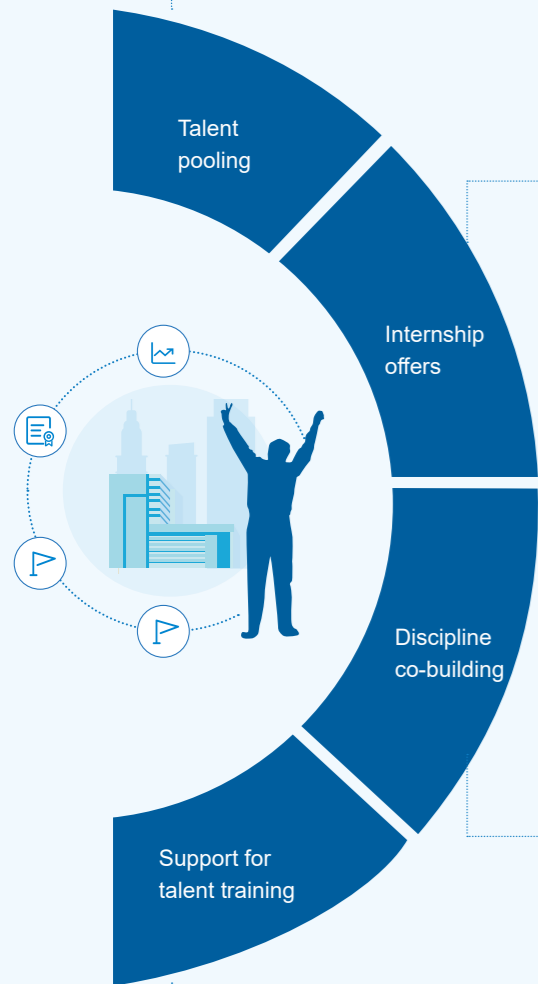

We have established the Sailor Recruitment Project, which targets international students in China from developing countries and foreign workers who are willing to work in their homelands and provide them with internship offers. They will receive intensive training in our headquarters and those with excellent performance in the internship appraisal will be given full-time offers and work at the headquarters or in their homelands. We have concluded agreements with multiple universities on cooperation on a practice basis for the Sailor Recruitment Project. In 2023, we recruited a total of 11 international students in China. We endeavor to ease the worries of foreign employees about working in China by assisting them in obtaining work visas and providing them with dormitories. We help foreign employees more rapidly adapt to the workplace in China and improve their career competence through serial courses on themes such as products, markets, customer services, and marketing. Meanwhile, as foreign interns can enjoy the same activity benefits as our full-time employees do, we encourage them to participate in our traditional cultural activities so that they can learn about Chinese culture better and enhance their sense of belonging to us.

In September 2023, the Talent Training Project with Industry-Research Cooperation and Coordination submitted by Geehy Microelectronics, one of our subsidiaries, to the Ministry of Education was officially approved. The project consists of six projects that can be classified into two categories, namely the Projects on Reforming the Course Content and the Curriculum System as well as the Practical Conditions and the Construction of Practice Bases. The goals of the project include promoting the application innovation and practice of domestically made APM32 and G32A MCUs, building a domestic universal ecological platform for chips, providing intensive support for curricula construction and educational reforms by teachers and students in HEIs, deepening university-enterprise cooperation and industry-education integration, and facilitating the application innovation of domestically made chips in such fields as industrial automation, smart agriculture, new energy, electricity & power grids, and automotive electronics. It also involves in-depth research on the application technologies of chips to support the innovative research and applications of domestically made chips, supporting the reform of engineering education in China and bringing new blood to the semiconductor industry in China.



We Were a Co-host of the 6th China Postgraduate IC Innovation Competition

In August 2023, Geehy Microelectronics served as an honorary partner of the 6th China Postgraduate IC Innovation Competition under the guidance of the Department of Degree Management & Postgraduate Education of the Ministry of Education, where it set two enterprise questions that focused on hot topics of the industry, such as the UWB location tracking technology and laser ranging, a solid effort to facilitate industry-education integration and support talent training in the field of IC.





We Held the First "Geehy Microelectronics Cup" IC Innovation Training Camp

Xidian University is among the first of nine National Demonstrative Schools of Microelectronics and is ranked among the top four universities in China in terms of majors in electronic and information engineering. From November 2022 to March 2023, Geehy Microelectronics cooperated with the university to hold the first "Geehy Microelectronics Cup" IC Innovation (Xidian) Training Camp. While four training orientations were set, a total of 141 students received training in the program. On May 28, 2023, we co-hosted the closing ceremony for the camp and the ceremony for the conclusion of the university-enterprise cooperation agreement, where we had an in-depth communication about the cooperation in talent training.



7.3.3 Optimizing the talent training system

We hold an unswerving belief in the role of talent as a core driver of corporate development. Therefore, we are dedicated to the continuous optimization and improvement of the talent training system to ensure that our employees' professional skills and comprehensive quality can stay up-to-date and satisfy our demand for development. We have carried out a series of internal training programs on such themes as onboarding training, professional skill improvement, and management ability training. Meanwhile, we actively seek cooperation with external professional institutions and introduce diverse professional training resources and courses. In doing so, we have prepared a broad learning platform and a more abundant knowledge system for employees and laid down a solid talent foundation for our long-term development and improvement of market competitiveness.

Internal training

For the purpose of talent development and talent pooling, we continuously improve the system for developing Ninestar University, provide all-round and diverse training programs for our employees (including employees of our subsidiaries), and set up two training lines (one for professional talent and the other for management talent). Moreover, by creating hierarchical training modes, such as the Navigation program series, professional training camps, and onboarding training, as well as a series of high-quality training courses, such as Project Management, Structural Thinking, Business Negotiation Skills, Management for Efficient Meetings, and Time and Objectives Management, we focus on improving the professional skills and management abilities of employees and satisfying their demands for career development while improving our production efficiency and productive value.

By summarizing the professional capabilities required for key positions according to the features of different positions and the business demands, we are able to create special professional training programs to improve the capabilities of professionals and solve real business problems. In 2023, we organized eight professional training camps, including the internal lecturer training camp, the lean production training camp, and the supply chain training camp. Additionally, we help new graduates recruited via campus recruitment rapidly adapt to the workplace and achieve a preliminary mastery of workplace skills. In doing so, we have created an employee training mode that can facilitate the transformation of an employee from a newbie to a veteran.

Project name	Progress	Built-in courses
Navigation leadership training programs	Cadre classes offer practice-integrated courses that are designed to improve the management abilities of members of our management at the level of supervisors or above.	<ul style="list-style-type: none"> General manager classes Director classes Reserve director classes Manager classes Reserve manager classes Supervisor classes
Professional training camp series	The training camps are applicable to multiple business lines, including the supply chain, project management, and R&D, with an orientation towards eliminating professional bottlenecks. In the name of these training camps, activities for the Action-based Learning and Improvement Week are carried out to help talent learn from practice.	<ul style="list-style-type: none"> Marketing training camps Internal lecturer training camps R&D innovation training camps Lean production training camps Supply chain Supply chain training camps HR elite training camps Finance elite training camps English training camps Project management training camps
Team building for internal lecturers	This year, the Lecturers Forum of Ninestar University offered eight-course sessions in three sections, namely workplace skills, self-management, and professional capability improvement.	<ul style="list-style-type: none"> Course development and design Exhibition of the charms of lectures Lecturers Forum Internal Lecturer Competition Activities on Teacher's Day
Training for technical professionals	We provide targeted skill training for employees in core positions, such as cartridge maintenance, replenishment procedures, the refilling process, training in automated operation for cartridge workshops, and operation procedures for positions at risk in die-making shops and injection molding workshops. Additionally, we organized 96 lean production training sessions within the scope of the Group this year, which significantly improved the lean production skills and production efficiency of 1,755 employees.	<ul style="list-style-type: none"> Training for obtaining electrician certificates Training in automation Training for lean production Self-evaluation of occupational skill levels
Onboarding training	Onboarding training is offered for both employees recruited via campus recruitment and social recruitment. Employees recruited via campus recruitment need to attend the Ninestar Classes, in which training is offered in three stages (namely, Setting Sail, Experience and Growth), while the Company Culture, our regulations and policies, and the knowledge of our systems and positions are publicized and delivered to employees recruited via social recruitment.	<ul style="list-style-type: none"> Theoretical training Self-directed activities Outdoor activities

Performance on Talent Training



New graduate training

To help students rapidly adapt to the workplace and change their perceptions of roles into the right ones as soon as possible, we held the 2023 Ninestar Class for a total of 112 new graduates recruited via campus recruitment, offering them intensive training, quality development training, advanced courses, and workshop internships and helping them quickly adapt to the workplace. Besides intensive training, during which they paid visits to the Zhuhai Museum and participated in team-building activities, practice-based courses and workshop internships were offered to improve their familiarity with our production status and product structure.

Moreover, we have formulated the plan for setting mentors for recruited new graduates and the mentoring handbook, as well as set apprentice-mentor meetings and apprenticing ceremonies to enhance the mutual understanding between recruited new graduates and their mentors. As we have set three training stages for recruited new graduates on probation, their mentors are required to formulate mentoring schedules at the beginning of each stage and report the mentoring performance at the end of each stage, while the Human Resources Department needs to provide support for the tracking of the mentoring process, select model mentors for each stage according to the results of the mentoring performance appraisal, and grant incentives to outstanding mentors through appraisal and election at the end of the probation period.



⁵The statistics on employees of some of our overseas subsidiaries by gender are unavailable due to the restriction of their local laws and regulations.
⁶Foreign employees are also included when the statistics on the training hours are prepared.

Cooperation with external institutions in improving employees' skills

In 2023, we cooperated with external institutions to organize six professional training camps. Specifically, in the R&D innovation training camp, we incorporated a project management training camp and introduced a strategy decoding course in Q4; in the supply chain training camp, we delivered three professional lectures and prepared the safe inventory plan for each supply chain sector; and in the internal lecturer training camp, while 41 employees completed the training and were recognized as the Group's junior lecturers by training, 46 relevant courses were developed, covering marketing, general office skills, human resources, the supply chain and relevant technological systems, and production management.



During the Reporting Period, we carried out the Navigation leadership training programs to improve the management abilities of reserve cadres and newly promoted cadres, grouping them into six classes. Specifically, in the director class, the training was combined with themes such as cost reduction & efficiency improvement, information-based management, and learning from benchmarking enterprises; in the manager class, all 48 trainees finished the question-based training, with six courses completed and 158 real problems at work, including the obsolete inventory and the rate of man-hours for quality abnormalities was solved; and in the supervisor class, online (two sessions) and offline (seven sessions) training was prepared for a total of 52 newly promoted supervisors, who had completed 77% of the training content.



Markstrat training

We cooperated with Linkstar to offer 48 members of our management drill-based training in strategic marketing simulation with Martstrat. Through five days of on-site marketing simulation, the trainees engaged in simulated marketing based on their knowledge of five marketing dimensions, improving their strategic thinking, product thinking, business thinking, and management abilities.



With the expansion of Pantum's operations in foreign markets, we are in possession of a rapidly growing team of international talent. To further standardize employee training and selection, we continuously improve the system for position qualification, categorize employees' capabilities to select country managers and country manager candidates, and invite employees of our overseas subsidiaries to receive training in China. In 2023, we provided our 29 global country managers with rotational training in our headquarters for the extension of required knowledge, the improvement of practical skills, the identification of our Company Culture, and team building.

Regular training of foreign employees

With the expansion of our operations in foreign markets, we are in possession of a rapidly growing team of international talent. We are clear about the significance of building and training a team of international talent for our continuous development, so we have formulated a complete set of regular training programs for international employees. In 2023, we carried out training programs for international employees, of which the carefully designed content included but was not limited to the extension of required knowledge, the improvement of practical skills, the thorough identification of our Company Culture, and enhanced team building. We aimed to promote their understanding and mastery of our history, our products and marketing management, improve their comprehensive capabilities in an all-round manner, and help them better adapt to our team, improve their business capabilities, as well as contribute to our long-term development.

Foreign Employees Were Learning Our History and Products

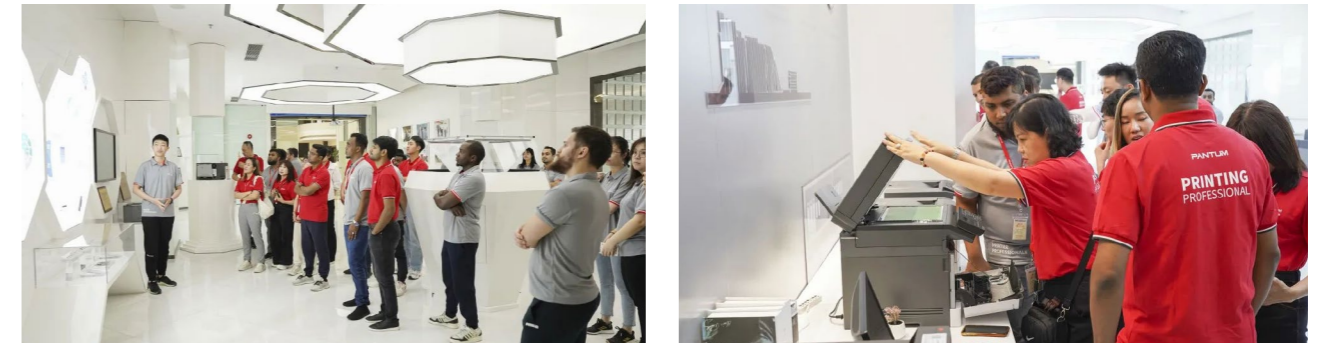

Foreign Employees Were Learning Marketing Management



Special online training program of Zhuhai City

We are in collaboration with the local Bureau of Human Resources and Social Security so that we can use their online training platform to obtain rich resources for online training. With these resources, we can provide targeted training courses based on the different positions of our employees, facilitating the improvement of employees' professional skills. The statistics from the bureau's online training platform show that 1,657 of our employees had completed the special online skill training program of Zhuhai City in 2023, with the average training hours per employee exceeding 10 hours.

7.3.3.4 Support for on-the-job education

To improve employees' knowledge and skills for duty performance, we have formulated the In-service Degree Education Management System, providing relevant incentive policies and stipulations on attending on-the-job education degree programs, improving occupational skills, and improving professional skills. With the improved management procedures, we encourage all official employees to attend training programs to obtain an occupational certificate or a higher education degree. Moreover, we will cover a certain amount of the expenses for employees in obtaining an on-the-job education degree, a professional technical certificate, or an occupational certificate and grant them suitable awards. In doing so, we endeavor to ensure that our work of supporting on-the-job education has a positive effect. During the Reporting Period, we granted 133 employees CNY261,600 as awards for obtaining a higher education degree.



During the Reporting Period, we granted

133

employees



CNY

261,600

as awards for obtaining a higher education degree.

To improve employees' occupational skills, we enter into cooperation with credit-worthy educational institutions as necessary every year, as well as regularly provide external training and invite lecturers to provide training. By offering courses such as the Activity Themes of Problem-solving QCCs, the Activity Themes of Innovative Subject QCCs, Six Sigma in Project Management, the Whole-process Management of Accounts Receivable, and Condensed EMBA Training, we provide our employees with rich and useful resources of training for obtaining a higher education degree and improving general and professional skills.



To encourage employees to actively seek a higher education degree, we provide employees with access to multiple educational institutions and learning channels as a solid support for their on-the-job degree education. During the Reporting Period, we cooperated with two third-party institutions (Taiqi Education and Baitai Education) to publicize on-the-job master's programs among employees and programs for a higher education degree among employees who were not college graduates or were junior or regular college graduates. We also cooperated with Guangdong Technology College, the Zhongshan Institute at the University of Electronic Science and Technology of China, and Shantou University to encourage employees who were not college graduates or were junior or regular college graduates to seek a higher education degree.

In 2023, our Group recorded 52 employees who had obtained a higher on-the-job education degree, including 27 who became junior college graduates, 23 who became regular college graduates, and two who obtained the on-the-job master's degree, whom we support with policy-backed tuition awards.

We value the training for employees' professional skills, formulate training plans as needed every year, and provide rich professional skill training programs both online and offline. We cooperate with education and training institutions and use these social learning platforms to develop multiple special training programs for employees and improve their general and professional capabilities.



Condensed EMBA Training

We offer drill-based education. In 2023, we offered 23 Group Directors a course of condensed EMBA training so that we could efficiently change the ideas of managers and improve the managers' management capabilities through course-based learning and mentoring.



7.3.3.5 Improving promotion channels

To ensure a transparent, equal, and fair promotion system, we have formulated the Position Management System, the Cadre Management System, and the Management Mechanism for the Development of Cadre Positions. In doing so, we have optimized the position remuneration system and standardized the duties of employees at all levels in a strict manner. According to the different characteristics of employees, we offer them diverse channels of career development and various models for talent capabilities in terms of management directions and professional orientations, including the channel of development for the technical sequence, the channel of development for the marketing sequence, and the channel of development for the management sequence, allowing all employees to have their own development orientations and objectives. The promotion of employees in the technical sequence is based on the system for position qualification, as only employees who qualify for assuming their positions due to the fulfillment of relevant requirements for knowledge, skills, work results, and other criteria may be promoted. Moreover, the promotion of employees in the management sequence should depend on whether the criteria for the results of annual performance appraisals, training attendance, personal insights into cadre competence and experience, reading notes, defense reporting for promotion, etc. are satisfied.

To ensure equal and diverse promotion appraisals, we examine and select candidates by comprehensively taking multiple factors into account rather than according to the results of a single performance appraisal. We give preference for promotion to employees who have both good capabilities and performance, and adopt a hierarchical system for extra benefits and incentives for talent. Meanwhile, to ensure fair promotion interviews, the interviewers should strictly follow the principle of restrictions to prevent nepotism, cliques formed to pursue personal interests, etc.



7.3.3.6 Incentives for talent development

To attract and retain excellent management talents and business support staff, allow employees to share our long-term value growth, and arouse the passion of all staff for persistent contribution to our development, we have formulated the Restricted Stock Incentive Plan for directors, senior managers, middle-level managers, and core support staff, as well as others for whom the Board of Directors deems incentives necessary, improving our medium- and long-term incentive mechanisms. In 2023, we actively promoted reserved stock granting according to the 2022 Restricted Stock Incentive Plan, granting 230,800 restricted stocks to 35 people as incentives. Meanwhile, we continued to research the diversification of stock incentive tools based on our actual development status and the establishment of a system for incentive mechanisms that integrate long-term incentives, short-term incentives, and restrictions that can align with the incentives, supporting our long-term development. Moreover, in March 2024, we engaged in a new round of stock incentive granting, granting 40,340,400 stock options to be exercised in three stages to 2,102 employees, showing our resolution on talent incentives.



Annual Commendation Meeting for Outstanding Employees

At the end of March 2023, we successfully held the Annual Commendation Meeting for Outstanding Employees for 2023 to show our sincere respect and gratitude for outstanding employees in the previous year. In 2023, the outstanding employees made significant contributions to our development with their relentless efforts and remarkable achievements. Their performance was not only widely recognized by their colleagues but also proved to be valuable and exemplary to us. To honor and reward their hard work and remarkable performance, we decided to grant them cash bonuses, a material effort to express our recognition and appreciation for their diligence. We hope these efforts can further increase their sense of belonging to us and their loyalty to us, as well as inspire more employees to actively go about their work, give play to their potential and creativity, and contribute more to our development.



Indicators and objectives

Objectives

- Checking the talent pool, focusing on the demand for talents in key positions, and recruiting excellent talent via social recruitment, campus recruitment, internal referral and other means.
- Regularly implementing university-enterprise cooperation, enhancing the interaction with universities, as well as faculty of disciplines, that match well to our business sectors, promoting our employer brand, and creating new talent pools.
- Improving the channels of talent promotion, building a talent pipeline, and providing bigger platforms and better remuneration for excellent talent.
- Developing a more scientific talent training system, designing targeted, quality business courses for the onboarding training of new employees on probation, the on-the-job training of employees for professional skills, and the training of middle-level and senior managers for management abilities, and enhancing the building of the training team.

Progress

- In 2023, we recruited a total of 11 international students in China through the Sailor Recruitment Project.
- The Talent Training Project with Industry-Research Cooperation and Coordination submitted to the Ministry of Education was officially approved.
- We actively promoted reserved stock granting according to the Restricted Stock Incentive Plan, granting 230,800 restricted stocks to 35 people as incentives.
- We held the 2023 Ninestar Class for a total of 112 new graduates recruited via campus recruitment, and cooperated with external institutions to hold six professional training camps.

7.4 Product Responsibility

7.4.1 Concept

We are fully aware of the significance of product quality for a manufacturing enterprise. We always put product quality and safety as the first priority while improving our product quality management system to ensure the satisfaction of products with safety and quality standards in design, production, and marketing processes and improve the user experience of products from all aspects. On top of that, we enhance user experience and develop more intelligent, caring, and responsible products for customers through intensive R&D and innovation.

7.4.2 Strategies

We strictly observe the Product Quality Law of the People's Republic of China and the Quality management systems-Guidelines for the application of GB/T19001-2016, and have formulated several internal documents such as the Quality, Environment, Occupational Health and Safety Management Handbook and Total Quality Management System. Each subsidiary has formulated internal quality management systems such as the Product Inspection Specification and Product Mass the Product Mass Production Quality Management Procedure according to the relevant situation. The systems stipulate the product quality control process in the trial production, inspection, and mass production stage to ensure the consistency and stableness of the product and fully promote the quality management ability of the Company.

Our product responsibility management strategy centers on risk management, policy building, and objective setting and highlights process control and regular compliance inspections in order to implement product responsibility management on all fronts and better protect consumers' rights and interests and maintain our brand reputation.

7.4.3 Actions and practices

7.4.3.1 Quality risk control

By referring to the systematic method guidelines of ISO 9001, we formulated internal policies such as the Quality Risk Assessment Process, as well as annual quality work plans that contain the work plans for quality inspection and control and the plans for continuous improvement of the comprehensive quality management system. Through whole-process management of audit and quality, we have achieved product quality risk prevention and control for each process.

Product design

At the design stage, we fully consider product safety, strictly control the introduction of product safety demands, solution formulation reviews and test evaluation etc., and set up the "evaluation-improvement" closed-loop mechanism.

Material management

We control the brands of key raw materials, inspect incoming materials, randomly inspect key raw materials each month, and maintain effective tracking and strict management of the inspection, use, and warehouse exit of raw materials, as well as changes in the supplier's materials and processes. We also control the quality of semi-finished products and purchased products to ensure the stability of incoming material quality.

Regular review

All subsidiaries of Ninestar conduct annual audits on the operation control, promote and follow up on the rectification results according to the results in order to ensure the prevention and control of the quality risks.

Customer feedback

Customers' and consumers' feedback and complaints are recorded in detail. Complaints about product quality and services are handled in a closed-loop manner in accordance with the Customer Complaint Handling Process, and customer feedback is taken as an important reference to continuous adjustment and improvement.



Pantum Quality Month Activity

We view product quality as the lifeblood of enterprise development, and the Quality Month activity is an important measure for us to actively promote the development of a quality-driven culture and enhance employees' quality awareness. In the past, the Quality Month activity was carried out randomly every month, and was limited and passive by nature. In order to further improve product quality, we have incorporated the Quality Month activity into the annual plan and annual practice. Under this new model, we encourage employees involved in all processes and across all positions to exert their independent awareness of quality responsibility and change their mindsets from "I do as instructed" to "I do because I want to", while carrying out "Do It Right The First Time" quality training and education. Through quality awareness training, quality control standards, and requirements and analysis of quality improvement cases, we stimulate employees' subjective initiative and active participation and keep enhancing employees' quality knowledge and skills to make them more capable of coping with quality risks and participating in quality management in practices.

7.4.3.2 Quality security certification

All of our major subsidiaries have gained the ISO 9001 quality management system certificate and the products of some of our subsidiaries have passed a number of international security certifications, such as the EU Electromagnetic Compatibility (CE-EMC) Certification, China Environmental Labeling certification, UKCA Certification, EU RoHS (Restriction of the Use of Certain Hazardous Substances in Electrical and Electronic Equipment Directive) Certification and Nordic Environmental Label Certification, satisfying the laws and regulations on product marketing.

Our laser printer products have passed product certifications related to electrical safety, electromagnetic compatibility (EMC), and energy efficiency in 42 countries and regions, fully demonstrating the highest stability and safety of our products in the global market, as well as satisfying the requirements of different countries and regions.



In terms of automotive chip products, our microcontroller units (MCU), ultrasonic transducers and signal processors, and a variety of electronic chips for automobiles have passed the ISO 26262 Functional Safety Management System Certification, EU Electromagnetic Compatibility (CE-EMC) Certification, RoHS Certification, and REACH (Registration, Evaluation, Authorization and Restriction of Chemicals) Certification, and obtained 13 AEC-Q100 Grade1/Grade2 reliability certificates. The relevant hazardous substances have been tested as qualified and we have achieved mass production for all these products. In addition, Geehy Microelectronics is the first enterprise in the Guangdong-Hong Kong-Macao Greater Bay Area to obtain the highest level of TÜV Rheinland ASIL-D certification under the ISO 26262 Functional Safety Management System.



In terms of compatible supplies, our products have passed Nordic Environmental Label Certification and IECQ Certification, and our subsidiary, Ninestar Information Technology, won the Laboratory Accreditation Certificate from the China National Accreditation Service for Conformity Assessment (CNAS), fully demonstrating our competence and standards as to quality control system.

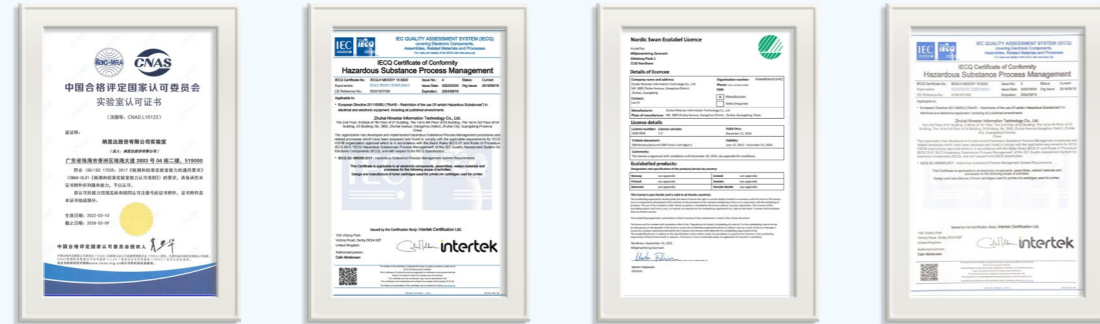

Mass Production and Roll-out of Brand-new A3 Printers

In 2023, Pantum rolled out five brand-new self-developed A3 monochrome and color printers. These A3 multifunction printers use duplex imaging technology instead of simplex imaging technology and are able to print, photocopy, and scan, meeting different printing needs in practices. They are also durable, highly reliable and stable, and easy to maintain, costing little to use. The successful development of Pantum A3 multifunction printers has further enriched Pantum's high-end product pipeline and enabled Pantum to develop full knowledge of the core techniques of A4 and A3 monochrome and color printers and the industrialization technology of whole-machine development, marking the improvement of our R&D and quality control capacities.



7.4.3.3 R&D and innovation

R&D and innovation are the core that drives enterprise development. Since our establishment, we have attached great importance to the R&D and innovation of products and technologies. In 2010, we rolled out our first Pantum laser printing in the Greater Hall of the People after 1,000 days and nights of independent development. This is a milestone that highlights our breakthrough in technology development and marks China's critical progress in the global printer industry, laying the foundation for the rise of China's printer manufacturing industry.



From the roll-out of the first self-developed Pantum laser printer to today's complete product-line supply, our R&D team has been committed to integrating innovative technologies into products for a more efficient and convenient printing experience. We keep introducing new products, including test paper renovation products and WeChat remote printing products that save effort and money, as well as durable and reliable products that save energy and cost to meet user demands and improve user experience. Our reliable technologies ensure complete product-line supply and high-quality and high-reliability printing services for users, as well as more efficient, convenient and cost-effective printing solutions for customers.

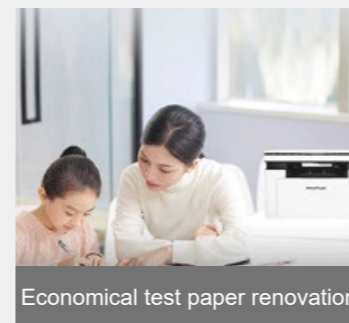

Economical test paper renovation

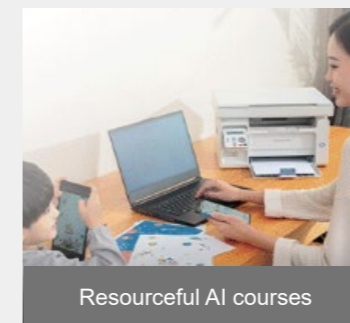

Resourceful AI courses

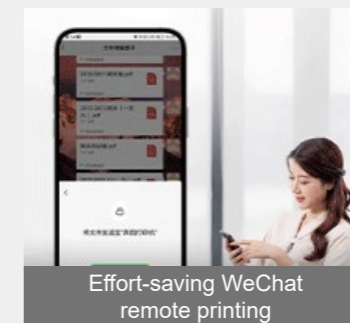

Effort-saving WeChat remote printing



Convenient office printing



Energy- and cost-saving, durable and reliable



Reliable technical support



Windows and iOS compatible



The New R&D Base - Pantum Intelligent Printer Industrial Park - in Feidong, Hefei, Was Officially Put into Operation

In 2023, the first domestic printer industrial park, Pantum Intelligent Printer Industrial Park, in Feidong, Hefei, Anhui Province, put into operation its entire production line. The industrial park will become our R&D base for high-performance laser printers, a software compatibility center, and a production base of printers and supporting products. As our second production base for high-end, intelligent manufacturing in China, construction of the industrial park started in September 2022, and the successful commencement of its first product line marks a new milestone of Pantum's industrialization process and a new step of comprehensive development of China's printing economy.



The commissioning ceremony



Geehy Microelectronics Rolled out the High-performance MCU for Motor Control

The high-performance, highly cost-effective APM32F035 MCU for motor control rolled out by Geehy Microelectronics integrates a variety of mathematical computing accelerators and a number of peripheral resources such as high-speed ADC, operational amplifier, comparator, and CAN controller and can greatly save hardware development cost and improve system performance and stability. For different motor application markets, Geehy Microelectronics also rolled out a series of highly representative mass-production application solutions for fans, water pumps, two-wheelers, and high-speed blowers. In particular, Geehy Microelectronics' APM32F035 MCU for high-speed laboratory centrifugal machines replaces the traditional square wave control solution with a brand-new high-performance vector control solution to enable the centrifugal machine to start running without sudden flipping and stopping. It can also accurately control the back charge voltage to reduce noise during ultra-high-speed running, with a better muting effect and accelerating and decelerating performance than existing products in the market, being an all-around product for motors.



Geehy Microelectronics Rolled out the Master Control + Communication Module for Sweeping Robots

Geehy Microelectronics' master control module for intelligent sweeping robots uses APM32F407 high-performance MCU featuring high dominant frequency, high performance, high integration, and resourceful peripherals and is capable of complex computing and abundant, accurate, and efficient locating and cleaning functions. It enables sweeping robots to run, rest, and sleep with ultra-low power consumption to effectively extend the service life of batteries and meet the low-power-consumption need of battery-powered products.

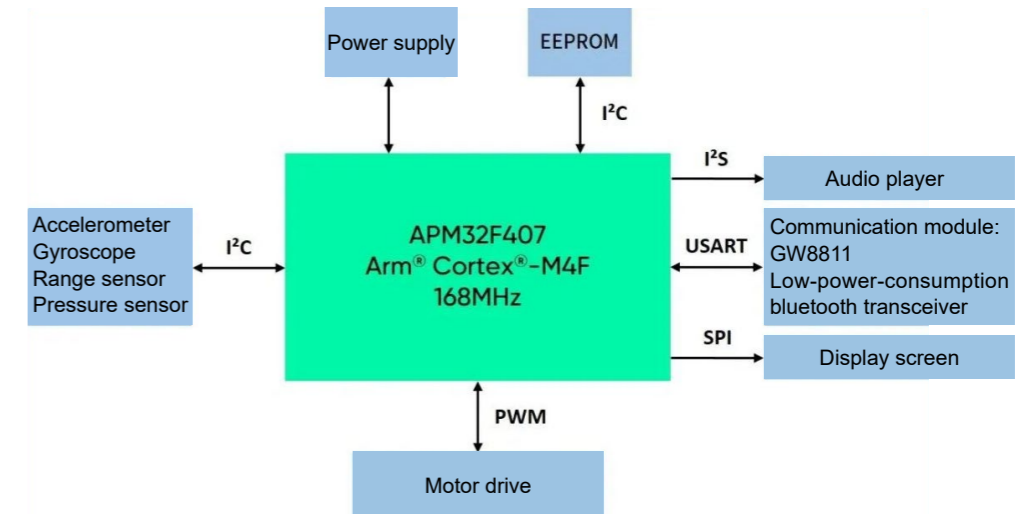

Geehy Microelectronics Rolled out the APM32F030 Outdoor Power Solution

Geehy Microelectronics' APM32F030 outdoor power solution adopts a PV solar panel with 300 W input power for charging to enable longer and more efficient outdoor battery life. It is also equipped with a variety of circuit protection functions, a number of protective features, an intelligent interactive LCD screen, and a variety of interfaces, providing safe and stable charging and discharging performance and better user experience.

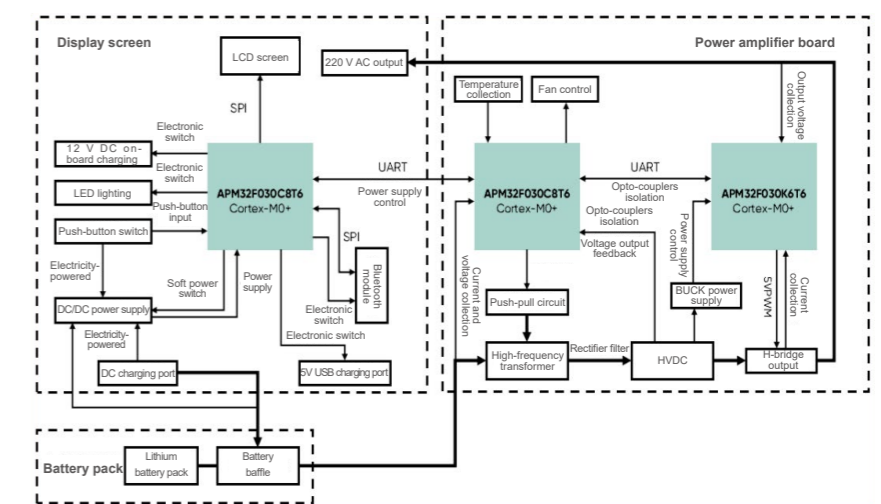

G&G is committed to providing consumers with cost-effective, environmentally-friendly supplies, including laser consumables, inkjet consumables, ribbon consumables, and copier consumables. We have more than 1,000 franchise stores in over 100 key cities in China and our sales outlets have covered in excess of 90% of China's cities and counties, meeting the growing needs of office customers. G&G keeps improving its user experience and has earned recognition from the market. For six consecutive years, it has ranked first on JD.com's lists of best-selling toner cartridge and ink cartridge brands. Upholding the mission of "enabling all Chinese people to use domestic consumables", we firmly believe that we will win the trust of the market through our high-quality products and will achieve higher levels of development of our high-quality products.

7.4.3.4 Market recognition



Geehy Microelectronics Won the Certificate of "High-quality Supplier of Automotive Grade Chips"

At the awarding ceremony of the "High-quality Supplier of Automotive Grade Chips" certificate held during the 2nd Automotive Chip Industry Conference, Geehy Microelectronics won the certificate of "High-quality Supplier of Automotive Grade Chips".



Geehy Microelectronics Won the "China Chip" Award

At the Hengqin-Zhuhai-Macao Circuit Industry Promotion Summit and 18th "China Chip" Awarding Ceremony held in September 2023, Geehy Microelectronics won the "Excellent Market Performance Product" award for its encryption chip based on a homemade CPU core. "Qiangxinbao", the special insurance product for automotive chips, is a key step for ensuring the localization, independence and controllability of critical chips. As one of the first integrated circuit design enterprises to join "Qiangxinbao", Geehy Microelectronics will contribute to the further development of the automotive chip industrial ecology.



Lexmark Won the "Best Data and Analysis Team for 2023"

Lexmark won the OnCon Icon Award for Best Data and Analysis Team for 2023 from OnConferences, marking the external affirmation of the significant organizational influence, excellent project innovation and leadership capacities of Lexmark's R&D team.



Lexmark Was Once Again Named among Quocirca Sustainable Development Leaders

In its report on the Outlook of Sustainable Suppliers in 2023, Quocirca, a global printing and market insight investigation company, once again named Lexmark as one of the Quocirca Sustainable Development Leaders in 2023. The report highlights the three major advances made by Lexmark in 2023, namely, its manufacturing plant in Mexico obtaining the CarbonNeutral® Manufacturer Certificate, its significant increase in the use of renewable energy, and its reduction of energy consumption by 26% from 2015 to the end of 2022 and reduced Scope 1 and Scope 2 emissions by 43% from 2015 to 2022. The Lexmark Laser Consumables Recycling Program (LCCP), the Lexmark Laser Printer Recycling Program (LECP), and the Lexmark Hardware Remanufacturing Program were all highly praised in the report.

Quocirca also highlights Lexmark's commitments, including reducing the use of non-returnable packages by 50% by 2025, increasing the use of post-consumer recycled (PCR) plastics in product mixes from the present 40% to 50% by 2025, increasing the use of PCR and reused consumables to 50% by 2025, and continuing to pursue the 100% EPEAT and ENERGY STAR® certification goals for hardware product mixes.

Lexmark CarbonNeutral® certified products

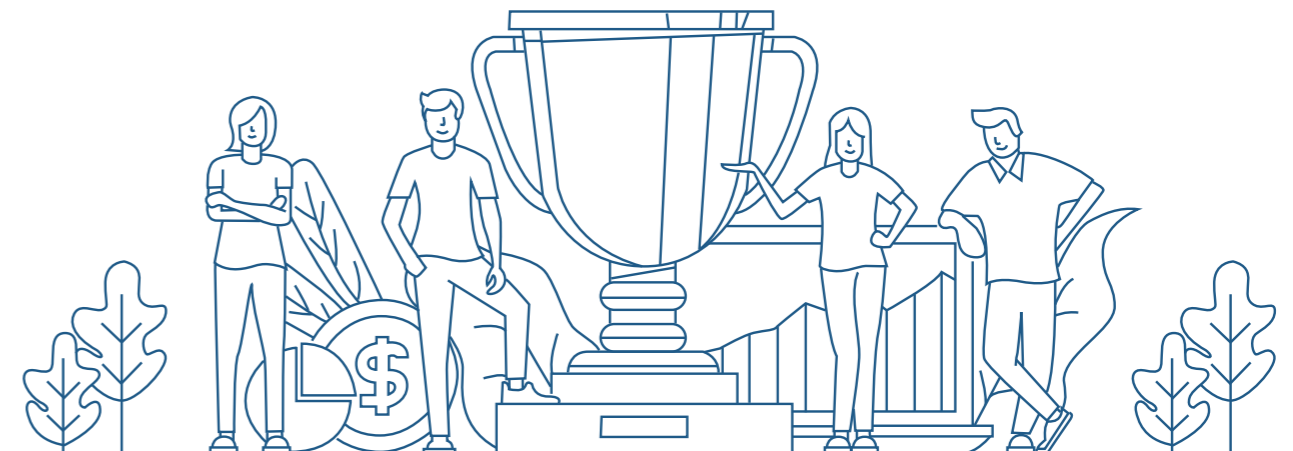



Geehy Microelectronics Won Two Awards at the China Computer Innovation Congress

On January 10, 2024, Geehy Microelectronics, as invited, attended the 2024 China Computer Innovation Congress hosted by the China Computer Industry Association and delivered its insights into the industry topic of "Digital and Intelligent Transformation Empowered by Computing and Innovative Development based on Supply Chain-Industry Chain Integration". With its remarkable achievements in core technology research and leading industry chain innovation, Geehy Microelectronics won the "2023 China Printing Consumables Industry Development Award for Outstanding Achievement", and its General Manager Wang Dongjie won the "2023 Entrepreneur Award for Outstanding Achievement".



G&G Won the Five-star After-sales Service Certificate

In early November 2023, an expert team reviewed all functional sectors and service processes of G&G covered by its after-sales service management system, product service management system and customer service management system based on 15 indicators such as quality assurance, product distribution, after-sales maintenance, customer satisfaction and complaint handling, according to GB/T27922-2011 Evaluation System for After-sales Service of Commodity. In one single review, G&G passed the first industry service certification for after-sales service based on national standards, and won the Five-star After-sales Service Certificate, the highest level certificate for after-sales service issued by the Ministry of Commerce.



Geehy Microelectronics Won the Title of "Little Giant" as a National Specialized, High-end and Innovation-driven SME

Since its establishment, Geehy Microelectronics has been focusing on designing chips for sub-industries and has made rapid progress in industrial control, automotive electronics, new energy and consumer electronics markets. In February 2023, Geehy Microelectronics won the title of "Little Giant" as a national specialized, high-end and innovation-driven SME for its years of deep cultivation in integrated circuit chip design and independent innovation capability.



7.4.3.5 Improving user experience

We keep enhancing our product competitiveness by producing efficient and durable printing machines, adopting ceramic heating technology, developing innovative large-capacity cartridge products, and integrating remote control, duplex printing, and other efficient, energy-saving, and ink-saving functions, winning critical acclaim from our users.



Brand-new Update to Pantum's Printing Mini Program on WeChat

Pantum updated its printing mini program on WeChat named "Pantum Cloud Print" to keep improving service quality. After the update, users can now print documents remotely on WeChat.

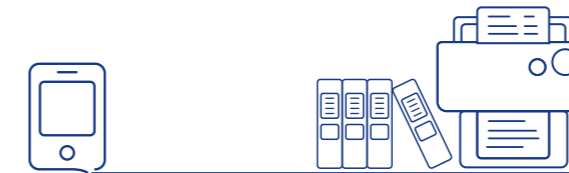

The Updated Pantum M6700DW Plus Monochrome Laser Multifunction Printer

The Pantum M6700DW Plus monochrome laser multifunction printer is an update to the previous generation. Updates include increasing the memory to 256MB and the processor frequency to 800MHz, adding low-power Bluetooth and 5G WiFi functions, and upgrading interactive experience. This user-oriented update to the product has significantly reduced operation difficulties and provides a convenient printing experience. The integration of a mobile app, WeChat mini program, and PC app has further improved multi-scenario accessibility to meet different user demands. The product prints quickly with consistent quality and meets both office and home printing demands with abundant printing templates and practical scanning and copying functions.





Pantum Printers Are Dedicated to Facilitating Teachers

We always see user experience as the core focus in product R&D and aim to provide users with efficient, convenient, and reliable printing solutions. For users in the education industry, we hope to facilitate teacher's work and support students' study with our products. Above all, we keep improving product competitiveness to supply efficient and durable printing machines. Pantum printers adopt advanced ceramic heating technology for faster printing and longer service life to ensure that users can enjoy more stable and durable printing services.

Second, we have rolled out our innovative large-capacity cartridge product to greatly reduce the frequency of cartridge change, improve printing efficiency, and reduce maintenance costs. Furthermore, remote control is made accessible on our printers so that users can operate printers remotely through the network.



Test Paper Renovation Effectively Supports Family Education

In the family education sector, we are committed to providing parents and children with the best possible learning tools through innovative products and functions. The Pantum BP2302W laser printer is the ideal choice for home printing. First, the A4-sized printer perfectly fits into the home environment, printing 18 pages per minute and completing printing tasks for parents and children with minimal effort. Second, the printer is equipped with a one-click handwriting removal function to make test paper renovation effortless so that children can print questions to which they have answered incorrectly on exercise papers with ease. Moreover, the printer emits noise of only 52 dB in running mode and only 30 dB in standby mode, enabling a peaceful learning environment at home.



7.4.3.6 Protection of intellectual property rights and patents

Our intellectual property right risks lie mainly in patents, copyrights, and trademarks. To further identify, prevent, and control the risks, we embed the strict examination of intellectual property rights risks into each business department and module and set up the specialty departments to approve documents for key projects. We follow up on each process of the product to assess and identify the risks and then propose suggestions about the solutions. Finally, we produce assessment reports to ensure the preventability and controllability of the intellectual property rights risks.

We carry out management and employee training for intellectual property rights protection, as well as risk prevention publicity and implementation for R&D personnel. We conduct promotional and implementation activities covering the themes of copyright protection, patent protection, trademarks, and advertising laws for business management personnel while providing online learning courses for all employees to participate in.

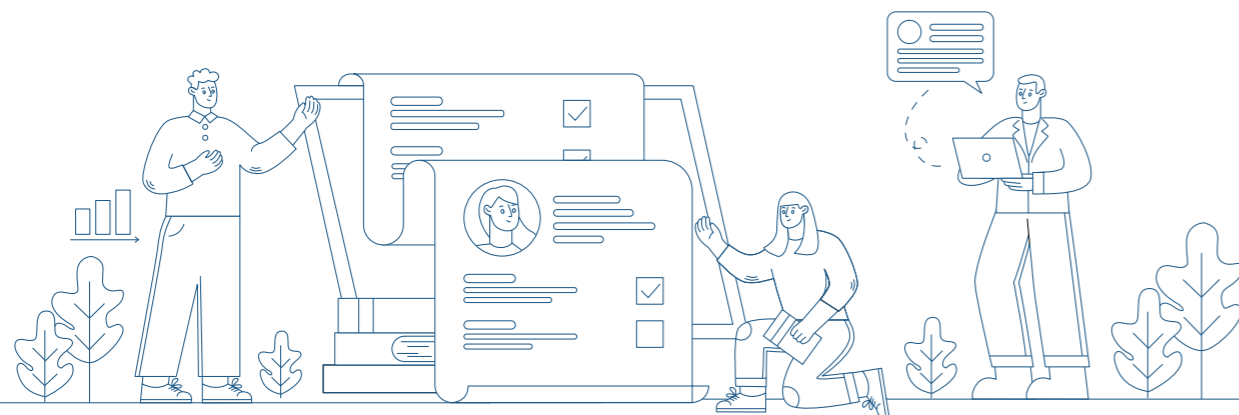
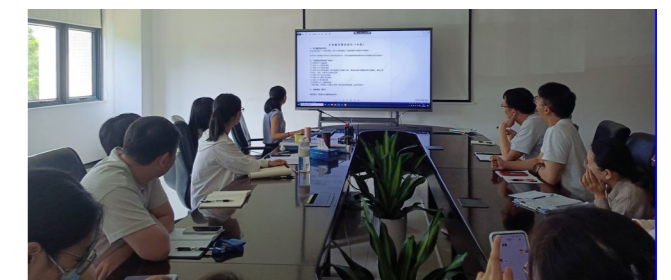

We have demonstrated a strong commitment and relentless effort toward innovation and R&D in terms of patent protection. Globally, we have set up nine R&D centers in different countries and regions to ensure that we can keep up with global technological trends and take in the most updated innovative thinking and technological results. Through the collaboration of these R&D centers, we have obtained 5,862 patents for our products, technologies, and services.

We are well aware that patented technologies are critical because they not only protect our development results legally but are also important embodiments of our innovation strength and market competitiveness. After ceaseless technological development and innovation, we have made a series of technological breakthroughs, which have made our products uniquely competitive and laid a solid foundation for our long-lasting development.

The perfect patent system we have built protects our intellectual property rights, eliminates the risk of technological results being infringed upon, and earns confidence and trust from our partners and customers. We will continue to increase investment in R&D, promote technological innovation, and enrich and improve our patent library to maintain our leading position amid fierce market competition.



7.4.3.7 Protection of consumers' rights and interests

We have taken resolute actions and introduced a series of policies and measures to combat unfair competition and counterfeit and shoddy products in the market. To create an orderly market environment and severely crack down on the manufacturing and selling of counterfeit and shoddy products and other illegal acts, we have taken special action and provided incentives and channels for the reporting of counterfeit and shoddy products.

- Informants who provide clues to illegal acts, actively cooperate with investigations, and help us locate the plants and stores making or selling counterfeit and shoddy products (including raw materials and semi-finished products) will be rewarded CNY20,000 to CNY100,000.

- Informants who have provided evidence and clues to counterfeit and shoddy products but did not participate in the investigation will be rewarded CNY200 to CNY2,000 if the clues provided agree with the facts as investigated.

- Informants who meet the above conditions will be rewarded according to the degree of harm and economic losses to us caused by the ascertained illegal acts, as well as the quality of the clues.

- Informants may contact us as follows and report such clues by email, phone, mail, visit or any other means.

- Official website: <https://www.pantum.cn/support/inquiry/report>

- WeChat official account: "Pantum Print" - Sales Service - Anti-counterfeiting, or "Pantum Service" - Self-service - Anti-counterfeiting.

- Pantum's official hotline for reporting: 0756-6930775 (in working days)

- Email: Supplies@pantum.com



7.4.3.8 Listening to consumer feedback

We understand that consumer feedback and comments are significant forces that drive our ongoing progress. Therefore, we conduct periodic user satisfaction surveys and respect and value the comments of every user to further improve our products and services, meet consumers' demands and expectations, and provide higher-quality products and services. In our 2023 user satisfaction survey, we collected feedback from the most extensive users through questionnaires and interviews and expressed our gratitude to certain respondents through lucky draws.

In 2023, we recorded customer satisfaction levels above



90%



[2023年度奔图用户满意度调研问卷]

7.4.4 Indicators and objectives

Objectives	Progress
Continue to lower the product rework rate	We carried out the Pantum Quality Month activity to promote the quality culture of "Do It Right The First Time".
Make service system management more mature	Our major products of the three principal business sectors passed a number of international security certifications.
Improve user experience	The mass production and roll-out of A3 printer marks the improvement of our R&D and quality control capacities.
Intensify the protection of intellectual property rights	Geehy Microelectronics won the "China Chip" award, and Lexmark was once again named among Quocirca Sustainable Development Leaders.
	Carry out periodic user satisfaction surveys
	We have obtained 5,862 patents for our products, technologies and services.

7.5 Privacy Protection and Information Security

7.5.1 Concept

We are aware of the significance of information security and privacy protection to customers. With technical support as the means, institutional constraints as the cornerstone, and continuous improvement as the driving force, we have built a comprehensive, dynamic, and sustainable information security protection system. We also take into account privacy production and information security in the process of product and service design to guard the safety and confidentiality of users' information.

7.5.2 Strategies

We attach great importance to information security management and privacy data protection and strictly abide by the Data Security Law of the People's Republic of China, the Cybersecurity Law of the People's Republic of China, and other relevant laws and regulations. Upholding our "Data Minimization" principle, we formulate comprehensive policies, perform periodic risk assessments, develop emergency response mechanisms, intensify security certification management, advance privacy protection and information security training, and orderly promote privacy protection and information security management.

We have formulated and issued the Management Measures for Personal Information Protection Management, the Guide to Personal Information Protection Compliance, the Confidentiality Management System, the Emergency Response Specification of the Information Management Department, the Management Regulation on Engineering Safety Control, the Management Regulation on Telecommuting, the Guide to GDPR Compliance and other management policies for data security and emergency response to specify and standardize the management regulations and requirements for information security and privacy protection. Furthermore, we organize security audits and assessments on a regular basis to identify potential security risks and develop corresponding mitigation measures and timely update software and systems to ensure complete conformity to privacy protection and security management requirements.

7.5.3 Actions and practices

7.5.3.1 Improving the information security management system

To intensify and improve our information security management, we have established the Information Security Management Committee for the overall management of all branches and subsidiaries of the Group and specified the responsibilities of each branch and department for information security management. The Chairman, Vice Chairman, and members of the committee are all information security experts with deep experience and professional expertise. The committee is mainly responsible for developing and managing our general information security system, formulating information security policies and supervising the implementation of such policies, ensuring effective protection of our information assets, preventing potential security risks, and creating a safe and reliable information environment to support our business operation and innovative development.



7.5.3.2 Reinforcing the construction of the information security system

To ensure thorough protection of our information assets, we keep strengthening the foundation of our information security system and have taken a series of measures to improve the information security level on the whole, covering physical access control, application system access, network security, and security certification and examination. We are committed to building a comprehensive, multi-layer information security protection system to effectively prevent and cope with information security threats and solidly guard the safety of corporate operation and customer data.

Physical access control

We have established a monitoring system. Through monitoring, we implement supervision and traceability for the areas with different security levels, such as office areas and workshops. We have also developed zoned and hierarchical management and control for personnel, set up different access control areas for different personnel, containing access control systems, metal detection doors and illegal entry alarms, etc.

Application system access

We have activated relevant access permissions to application systems by making an application and review according to the responsibilities and office demands of various people. Subject to the permissions, administrators access systems through the fortress computer, and external users access our internal network remotely through VPN and VDI, thus minimizing user permissions.

Network security

We have carried out the construction of the security domains of the whole company, separated personnel of various network areas through border firewall, Intranet firewall, anti-virus software, network access control, desktop operation management and network operation management measures, and conducted access control accordingly. As such, the objectives of protection, fragmentation, risk segregation and unified control have been achieved.

Security certification and examination

We actively promote major subsidiaries to pass the ISO 27001 Information Security Management System Certification and Grade 3 Information Security Protection Certification, demonstrating our professional and compliant information security management. Every year, we engage an external institution to audit ISO 27001 compliance of major subsidiaries to ensure continuous compliance with security standards. Besides, our Audit Department conducts annual audits of the security of our information systems.



Lexmark Achieved Excellent Security Through a Security Design Approach

In the face of increasing threats, the security approach of multi-layer printing based on software and services on top of hardware is gaining popularity. Lexmark's hardware product mixes are supported by extensive security consultation services and powerful cloud printing service products, meeting the security demands of organizations of all sizes. Lexmark's security services are composed of two pillars, with one being the security assessment service that analyses and assesses customers' existing printing environments and provides advice on how to improve their printing security settings and procedures, and the other one being the configuration management service that helps manage customers' printer group settings, firmware levels and access control.

Pantum Has a Fully-independent Chip Security Architecture, Strongly Supporting the Information Security of Printers and High-end Development of Homemade Printers

Printers are of extremely great significance in the information security sector, and are important parts of computer peripherals. After years of technological exploration, innovative development and technical accumulation, we have established a huge basic patent technology platform, and fully acquired various printer source codes and complete core software and firmware technologies, and we possess printer engines with independent intellectual property rights. Our printers adopt the master control SoC chip based on UMC28 and UMC40 nanometer process technology and the homemade heterogeneous multi-core embedded 32-bit CPU, and are capable of color printing, photocopying, color scanning and faxing. Our printers are equipped with the fully independent chip security architecture, feature high performance, prominent security strategy, China's national cryptography and commercial cryptography standards, and a security protection mechanism, and are strong support for the information security of printers and high-end development of homemade printers.

Ninestar Mall Guards the Trust of Every Customer with the Highest Industry Standards

Ninestar Mall has passed the Grade 3 Information System Security Protection Certification of the public security organ. This certification is the most authoritative information product security certification in China, and also the highest level of protection certification for non-banking institutions. Passing this certification and filing with the public security organ indicates that Ninestar Mall has industry-leading technical competence in information system security protection, and can effectively guard the safety and transparency of its information data in the communication process and practically address the trust issue and privacy protection issue in the data exchange process, and that we satisfy with national standards in terms of technological security and system management, and have established an appropriate network information security protection system.



7.5.3.3 Information security and privacy protection training

Ninestar concentrates on the construction of the security and privacy protection awareness of employees. We hold information security training and evaluation when the employees join the Company; we employ external professional institutions to regularly conduct themed trainings for the employees of each department; in order to promote all employees' consciousness of information and privacy security and highlight information security, we advocate daily information security for all employees in terms of laws and regulations, general network security common knowledge, password management, information classification and confidentiality, and internal communication precautions, etc.

7.5.4 Indicators and objectives

Objectives

Three-year objective: Perform refined security management of the Group, intensify software and network security management, and carry out audits of databases and codes

Five-year objective: Realize data grading and classification, continue to improve the "three center in two cities" architecture, and upgrade the hybrid cloud architecture deployment

In the following three to five years: Expand cloud and AI security control from the aspects of network security, application security, system security, terminal security and physical security, in order to support and facilitate our business development

Progress

We have refined the information security management system and formulated the Management Measures for Personal Information Protection Management and the Guide to Personal Information Protection Compliance.

We have been building up the information security system, and organizing regular information security and privacy protection training.

7.6 Occupational Health and Safety

7.6.1 Concept

We integrate the core concept of safety into our Company Culture, fully aware that occupational safety is a fundamental requirement for protecting the lives and health of our employees. We are committed to establishing a comprehensive management system for occupational health and safety, enhancing safety education for employees and stakeholders, conducting daily inspection rounds and regular maintenance, actively preventing and controlling potential safety hazards in the workplace, effectively preventing accidents during production processes, minimizing work-related health and safety risks to the greatest extent, and promoting the physical and mental health of our employees. We have adopted a series of management strategies tailored to the business characteristics of our headquarters and subsidiaries, striving for continuous improvement in employee occupational health and safety management performance to achieve best practice standards.

7.6.2 Strategies

We view our employees' physical and mental health as a crucial foundation for the Company's development, and we are committed to creating a safe and healthy working environment for our employees. In strict accordance with the Law of the People's Republic of China on the Prevention and Control of Occupational Diseases, the Work Safety Law of the People's Republic of China, the Provisions on the Administration of Occupational Health at Workplaces, and other applicable laws and regulations, the Company has formulated the Occupational Health Management System, the Occupational Health Management System, the Work Safety Management System, the Occupational Hazards Management System, the Hazardous Chemicals Management and Usage System, the Occupational Disease Hazard Warning and Notification System and other safety management policies, to build a dual prevention mechanism for hierarchical control of safety risks and identification and management of hidden hazards, for effective prevention of extra serious safety accidents. We are advancing the Work Safety Standardization Level Two Enterprise Certification at the Group level and securing ISO 45001 Occupational Health and Safety Management System certification for all major subsidiaries, with some subsidiaries already having achieved this certification. In terms of occupational health and safety management, we focus on enhancing and perfecting our safety management organization structure and responsibility mechanisms. The Group Safety Committee Office is responsible for overall coordination, with each major subsidiary staffing dedicated safety management teams to carry out daily safety management tasks. These teams conduct regular safety management meetings weekly, monthly, and quarterly. We have clarified the appointment processes for persons in chief charge of safety and safety management personnel and ensured that employees at all levels have signed the statement of safety responsibilities. We have implemented the responsibility system for all staff and purchased corresponding professional insurance policies, including work safety liability insurance and forklift insurance.



7.6.3 Actions and practices

7.6.3.1 Annual safety management priority initiatives

<p>Provision of safety equipment</p> <p>To provide employees with a healthy and safe working environment, we set access control cards and face recognition for restriction in a bid to strictly control the use of facilities by employees; provide necessary labor protection supplies for employees who need them, and install 24-hour surveillance cameras to identify dangerous disciplinary violation; use ventilation facilities and noise-reducing facilities and take other technical measures for prevention of occupational hazards; and furnish a medical room, eyewash equipment and other emergency facilities for occupational hazards.</p>	<p>Health examinations of employees</p> <p>We organize and carry out regular health examinations for our employees, providing our employees with occupational health checkups from before onboarding to departure and pay attention to specific positions that pose a threat to health, rotate employees' positions, and comprehensively ensure the environmental health and safety of employees.</p>
<p>Regular safety inspections</p> <p>We regularly conduct safety hazard inspections and emergency drills. Safety officers in production departments perform self-inspections and self-corrections daily. The safety management team organizes the persons in chief charge of safety for safety inspections every quarter. The safety supervision department carries out special inspections monthly, covering noise prevention and control, hazardous chemical management, building lightning protection detection, etc. Any discovered hazards require the responsible departments to respond and rectify within a specified deadline, ensuring continuous improvement of safety performance and timely correction of safety issues.</p>	<p>Prevention and control of occupational diseases</p> <p>We have invited professional testing organizations to the production sites for the detection and assessment of occupational hazards, and organized occupational disease examinations for employees holding posts exposed to occupational hazards.</p>
<p>Special safety inspections</p> <p>For the Company's major hazards, special inspections are conducted quarterly. A third-party safety service institution is engaged to inspect the potential safety hazards, special equipment, occupational health and dust removal system of the Company and to assess the risks in some new equipment or change in the process on a regular basis, and we carefully carry out special rectifications and take corresponding measures for such risks.</p>	<p>Safety culture promotion</p> <p>The Company has formulated documents such as the Administrative Provisions on Work Safety Education and Training and Employment with Certificates, and conducts work safety month and related safety training on emergency rescue, fire safety, dust explosion prevention, and special operations, etc. We provide the three-level onboarding safety education for common workers, and for safety managers, we conduct annual training for occupational health managers to work with certificates; we regularly provide special monthly educational training for those employees in positions exposed to occupational hazards and conduct ad hoc special occupational health training and education; we post posters about occupational safety to publicize national laws and regulations on work safety, work safety knowledge, and the Work Safety Management System of the Company, increasing all staff's awareness of the importance of health and safety.</p>

7.6.3.2 Occupational health and safety certification

We highly value occupational health and safety management and actively encourage our major subsidiaries to obtain the ISO 45001 Occupational Health and Safety Management System certification. Our implementation plan includes a comprehensive review and improvement of our current safety management systems to ensure they meet the ISO 45001 requirement standards. We will conduct specialized training and educational activities to raise employees' awareness of the importance of occupational health and safety and ensure they understand and are able to implement the new management system. Furthermore, we will collaborate with professional certification bodies to arrange internal audits and management reviews to assess our progress and identify further improvement measures. Our goal is to ensure that all subsidiaries not only achieve ISO 45001 certification but also continue to meet and exceed the requirements of this standard, enhancing our market competitiveness and sense of social responsibilities.



Occupational safety management performance data

 Investment in work safety amounted to CNY 20.1955 million	 The number of safety accidents was 0	 The number of work-related deaths of employees was 0
 The number of work-related injuries was 0	 The number of potential safety hazards rectified was 4,706	 The rectification rate of potential safety hazards was 100%
 The coverage rate of annual work safety and occupational health training for employees was 100%	 The training hours of production safety and occupational health were 35,638	 The number of participants in work safety and occupational health training was 12,224

7.6.4 Indicators and objectives

<p>Objectives</p> <ul style="list-style-type: none"> No deaths, fires, explosions, or other major accidents No accidents related to special equipment No industrial safety production accidents No serious injuries The incidence rate of occupational diseases is zero. Promotion of standardization of safety culture construction Advancement of all major subsidiaries through ISO 45001 Occupational Health and Safety Management System Certification 	<p>Progress</p> <ul style="list-style-type: none"> No deaths, fires, explosions, or other major accidents have occurred this year; no accidents related to special equipment; no industrial safety production accidents; no serious injuries; and the incidence rate of occupational diseases is zero. Full review and encouragement of improvement of existing safety management systems to ensure compliance with ISO 45001 standards
---	--

7.7 Community Philanthropy

7.7.1 Concept

As a socially responsible enterprise, we actively participate in social philanthropic undertakings, endeavor to give back to the community, and fulfill our due social responsibilities. Adhering to the corporate philosophy of "Mutual Creation, Mutual Sharing", we take the initiative to participate in welfare undertakings, resonating with national development strategies and actively undertaking our due social responsibilities while having a continuous and positive impact on the local community.

7.7.2 Strategies

With a strong sense of responsibility and mission towards the country and nation, we have made it our long-term strategy to actively fulfill our corporate social responsibilities. We actively respond to national strategies and have established the Ninestar Love and Public Welfare Management System, forming an institutionalized, systematic, and procedural social responsibilities management approach to ensure the effective implementation of related activities. In 2007, we partnered with the China Red Cross Foundation to establish the "Ninestar Angel Care Program" (formerly "Ninestar Angel Love Fund"), continuously carrying out activities in areas such as educational support, environmental protection, poverty alleviation, and critical illness assistance.

7.7.3 Actions and practices

7.7.3.1 Educational assistance

We are keenly aware of the importance of education to the country, communities, and families. As such, we focus on investing in education and have been committed to contributing to community development through educational assistance. We value and care for students because they represent the future of the country and their growth requires social attention and support. We will continue to pay attention to the development of education, actively participate in educational assistance, and contribute to building knowledge-rich and talented communities.



Providing Scholarship to Students of the University of Hong Kong

In 2023, we donated CNY 8.5 million to the University of Hong Kong to fund student scholarships and related expenses, representing our emphasis on and commitment to educational assistance. Our scholarship program aims to support academically excellent but economically disadvantaged students, enabling them to focus on their studies without worries and pursue their dreams. We believe that through our assistance, these students will be able to unleash their potential and contribute to societal development.

7.7.3.2 Community support

A good community environment is essential for the stable development of an enterprise. We consider it part of our responsibility to contribute to society and have developed a Company Culture based on giving back to society. We actively maintain contact with the community, deeply understand its development needs, and collaborate with various stakeholders to take practical and effective actions to improve local residents' life quality, promoting community development together. In the future, we will continue carrying out public welfare projects in fields such as culture, education, environmental protection, and critical illness assistance, providing support to those in need.



Sponsoring a Geo-environmental Risk Assessment Research Project at China University of Geosciences (Wuhan)

We sponsored a geo-environmental risk assessment research project at the China University of Geosciences in Wuhan. Focusing on the Tongmai-Gabajia area, the researchers conducted a study on the risk assessment of crustal stability, achieving significant scientific and practical results. To date, we have donated a total of CNY400,000 to this project. This philanthropic support in the field of geological research represents the initial steps of our Care Program in the scientific research sector and it has achieved our expected results.



Nursing Home Project in Tanghe County, Nanyang City, Henan Province

During the Reporting Period, we donated CNY720,000 to redevelop the previous site of Wangyingcun Primary School in Tanghe County, Nanyang City, Henan Province, into a new nursing home.



Following China's Belt and Road Development and Fulfilling International Social Responsibilities

We donated printers to schools in the Vojvodina province of Serbia to provide support to local educational institutions. We also visited the schools that received the Pantum printers along with the national education authority and the state education authority, which was reported by RTV, a local TV network.



7.7.3.3 Rural revitalization

To thoroughly implement the cooperation strategy in Zhuhai and Zunyi and pursue rural revitalization while consolidating achievements made in poverty alleviation, we joined forces with local vocational schools to develop a new model of integrating vocational education with industry and university-industry cooperation. By doing so, we aim to cultivate professional talent with technical skills that meet market demands to support the sustainable development of local economies. In addition, we actively responded to the national education assistance policy, took rural revitalization strategies into consideration, and initiated scholarship projects aimed at inspiring and supporting outstanding students to pursue study, cultivating more talent for our country.

7.7.3.4 Environmental protection actions

Pursuing green low-carbon development, Ninestar is always on the way. Since Ninestar became a member of the Society of Entrepreneurs and Ecology in 2014, we have been participated in various ecological projects such as the "One Hundred Million Ammodendron Trees" program for 10 consecutive years. This program is committed to planting 100 million ammodendron trees and restoring 2 million mu (1 mu is equal to approximately 666.67 square meters) of vegetation in the Alxa region, thereby improving the local ecological environment, curbing desertification trends, and enhancing the living standards of local herdsmen with the derivative economic value of these trees. As of 2023, we have donated a total of 29,000 ammodendron trees, covering an area of 580 mu.

7.7.4 Indicators and objectives

Objectives

To promote community development and carry out public welfare activities every year in fields which may include educational assistance, poverty alleviation, environmental protection, health care, etc.

Progress

We actively assumed our due social responsibilities and carried out a series of public welfare activities to promote work such as educational assistance, community support, rural revitalization, and environmental protection actions.



8. Environmental

We recognize the importance of environmental protection and energy conservation and have seamlessly integrated the core philosophy of sustainable development into the Company's business procedures. In order to constantly minimize the negative impact of its production and operations on the environment and ensure harmony between its long-term development and the ecological environment, we keep practicing green production and have adopted efficient waste management strategies.

Material issues	Response to GRI indicators	Chapter Navigation Contents
<ul style="list-style-type: none"> ● Green products ● Emissions management ● Energy management ● Water resources management ● Response to climate change 	<ul style="list-style-type: none"> ● GRI 301-307 	<ul style="list-style-type: none"> 8.1 Green products 8.2 Electronic waste recycling 8.3 Energy management 8.4 Waste management 8.5 Water resources management 8.6 Response to climate change

Response to SDGs



8.1 Green products

8.1.1 Philosophy

We earnestly conduct product lifecycle management in adherence to the philosophy of innovation and green R&D. We consider clean technologies as one of the core strategies of green product R&D, while paying attention to all phases, such as the design of the products with clean technology, green packaging and recycling. Moreover, we are committed to driving the input and application of clean technology and eco-friendly materials across all business segments through advanced production processes and equipment to reduce the environmental impact of the product lifecycle and manufacture eco-friendly and green products.

8.1.2 Strategies

Based on the management philosophy of product lifecycle management covering "R&D--Design--Material--Production--Recycling", we continuously push forward policy improvement, raise our investment in R&D, and set up management targets to manage green products.

R&D

We have established Incentive Policy for Eco-friendly Packaging R&D, which stimulates the team to actively propose innovative and green packaging materials and solutions and provides our customers with greener and more sustainable packaging solutions. Meanwhile, we keep raising investment in products with clean technology to reduce energy consumption of products.

Material procurement

We are committed to designing a sustainable portfolio of products and solutions using eco-friendly materials, parts, and components to minimize the environmental impact of the product lifecycle.

Product manufacturing

We have formulated management standards, such as the Regulations for the Management and Control of Hazardous Substances and the Control List of Hazardous Substances, strictly observed domestic and international standards for green products, such as the Measures for the Restriction of the Use of Certain Hazardous Substances in Electrical and Electronic Equipment, the Restriction of Hazardous Substances in Electrical and Electronic Equipment (RoHS), and the Regulation on the Registration, Evaluation, Authorization and Restriction of Chemicals (REACH), utilized raw materials in compliance with relevant regulations, and strictly controlled chemical substances, such as lead, cadmium, mercury, and hexavalent chromium, to ensure environmental friendliness of raw materials.

Product recycling

We stress the recyclability, degradability, and reusability of products, have formulated the Design Regulations on Toner Cartridge Packaging Process and the Design Regulations on Packaging Process of Ink Cartridge and Ink as the design standards for product packaging, and advocate the use of eco-friendly materials to improve the competitiveness in logistics costs and reduce the waste of packaging materials.

International regulations

We prohibit the export of electronic waste to non-OECD countries in line with international laws and regulations, such as the Basel Ban Amendment to the Basel Convention and the Stockholm Convention, and strictly control the use of persistent organic pollutants (POPs) and related hazardous substances in printer products. For instance, we practice refined management of halogen materials, such as brominated flame retardants (BFRs) and polyvinyl chloride (PVC).

8.1.3 Actions and practices

8.1.3.1 R&D and sales management of the products with clean technology

We have always been "market demand-oriented, technological innovation-centered" and continue to increase investment in clean technology R&D. Our overall R&D expenses in 2023 stood at CNY1,751 million. In order to further support technological innovation and R&D, we plan to invest more than CNY500 million in the next five years, mainly for clean technology R&D, energy consumption reduction, new fixture equipment upgrades, and low-power chips. Meanwhile, we have doubled our efforts for the identification and database accumulation of our current products with clean technology and promoted the necessity of clean technology R&D in the R&D department of each business to lay a sound foundation for strengthening the international competitiveness of our products.

We attach importance to the cultivation of talent in clean technology R&D and earnestly develop eco-friendly and energy-saving products, including low-power energy-saving printers, Unismart devices, and low-power chips. Concurrently, we use advanced and eco-friendly materials and designs to reduce energy consumption and waste emissions during the use of our products and enhance product recycling. Furthermore, we devote ourselves to upgrading technology and equipment, optimizing production procedures, reinforcing energy efficiency by developing energy monitoring systems and applying air compressors, and reducing the environmental impact of production activities.



Low-power fast heating technology based on ceramic sheets and fixing films

In order to raise the energy efficiency of printers and shorten the warm-up time, the research team studied low-power fast heating technology based on ceramic sheets and fixing films. A model of the heating system was created based on the advantages of ceramic sheets, such as fast heating, high heat transfer efficiency, and low heat loss, as well as the fixing structure consisting of ceramic sheets and fixing films. The heat transfer rate of the key parts and components for ceramic heating was improved, and a more refined on-demand solution to heating temperature control was used to reduce the printing temperature. It is expected that the energy consumption of the technology will be reduced by 50%.

We actively practice energy conservation in product design and enhance the energy efficiency of our products through continuous innovation and technological upgrading. Our products meet the energy efficiency and performance standards of all markets. All four new engines developed by Pantum are ENERGY STAR certified. Additionally, our branded printer series has passed the China Energy Conservation Certification from the China Quality Certification Center (CQC) and reached the China Energy Efficiency Level Standard Level Two or even Level One. Furthermore, we utilize advanced prisms and electronic chips for testing to meet more efficient technology requirements, further reducing our products' energy consumption.

We keep driving innovation and breakthroughs in clean technology and closely monitor the market performance of our products with clean technology. In order to manage and evaluate our products with clean technology more accurately, we have classified our green products into two categories, namely products with green design and products with clean technology, to establish more pertinent strategies for green product development and to raise the sales of green products. Our sales of green products amounted to CNY2,703 million in 2023, wherein the sales of products with clean technology reached CNY1,012 million, representing 37.44%.

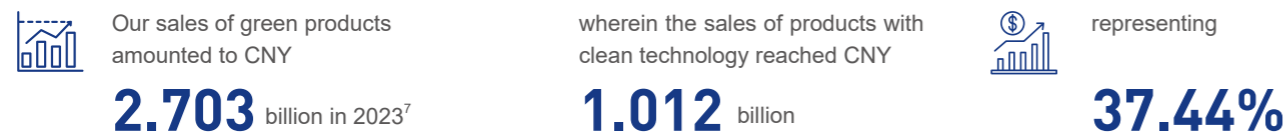

8.1.3.2 Green product packaging and materials

Green product packaging

We are convinced that green packaging materials indicate lifestyles and social values. We have endeavored to develop green plastic-free packaging that is recyclable, biodegradable, reusable, and eco-friendly, eliminated excessive packaging, and strictly controlled the discharge of hazardous substances. We primarily enhance the use of eco-friendly packaging materials through the following measures to reduce carbon footprint and resource consumption.

- We promote the use of recycled kraft boxes instead of traditional coated paper packaging. All our outer cartons for transportation are made from 100% renewable materials.
- The utilization of renewable materials has been increased in some materials.
- Molded pulp packaging was added to the packaging materials of our toner cartridge products in 2023 to achieve eco-friendly, plastic-free, and biodegradable packaging.

We have reduced the weight of packaging by approximately 3,000,000 kg since 2022, with an average volume reduction of 11%, in line with the requirement of light and thin packaging. The average freight per ink cartridge has been decreased by 22%. We have reduced the use of packaging materials by adopting a mini blister packaging solution. The weight of blisters has been reduced by 25% and the source of plastic pollution has been reduced by 6,000 kg per year on average.

⁷Lexmark data is not included here



Application of green packaging materials: Optimizing the packaging of toner cartridge products and ink cartridges

In order to minimize the use of plastic packaging in toner cartridge products in 2023, we used filler materials, such as paper cards and bags with high recycled content, in certain products to replace plastic protection, which not only increased the proportion of eco-friendly recycled materials but also strengthened packaging innovation and customer experience.

Our self-developed honeycomb core paper bags have a number of significant advantages compared with the old packaging. First, our patented paper eco-friendly material (ZL202320620126.3) is designed to abandon the traditional black paper bags and EPE foams and protect products. Second, the new package does not require inner wrapping materials, thus saving two processes and drastically improving production efficiency. This change reduces waste and saves storage space and transportation costs. The resulting cost savings represent more than 15%. Our eco-friendly, efficient, and low-cost new honeycomb core paper bags have become the industry's best practice in green packaging materials.



New Honeycomb Core Paper Bags

Old Packaging



Concurrently, we have optimized ink cartridge packaging. The traditional square packaging of ink cartridges sold online has been changed to flat packaging, thus reducing the thickness of cartons and shrinking the packaging volume by 35%. The streamlining of packaging not only reduces material costs and protects the products, but also meets the minimum requirements of e-commerce platforms for classification of logistics costs and product dimensions. The transportation cost is saved, as the average freight per box of ink cartridges has been decreased by 22%. Additionally, we have reduced the use of packaging materials by adopting a mini blister packaging solution. The weight of blisters has been reduced by 25% and the source of plastic pollution has been reduced by 6,000 kg per year.

By the end of the Reporting Period,



Persistent efforts have been made to reduce packaging materials. During the Reporting Period, built-in cartridges were used for the two new printers. The volume of some printers with an automatic document feeder (ADF) was reduced by 10%-30%. In line with our strategic objectives, we intend to replace the current plastics in the shells of some products under mass production with a large proportion yet low mechanical property requirements with recycled plastics by considering both cost and performance. Therefore, we will gradually replace the current product packaging with recycled materials or bio-based materials. EPE foams were used to replace all EPS in our printer products, toner ink cartridge products, and after-sales accessories in 2023. Meanwhile, we reduced the use of packaging materials by shrinking packaging volume, reducing stickers and packaging films, and replacing carton coating with water-based varnish.

Since 2022, to meet the requirement for light and thin packaging,



Green product materials

We adhere to the principles of reduction and harmlessness, give priority to the use of S1 raw materials and eco-friendly materials, and upgrade processes and technology. Meanwhile, we cut resource consumption, hazardous raw materials, and the generation and discharge of pollutants by minimizing the use of resources, reducing pollutant emissions, and optimizing production procedures.

The environmental specifications for our printer products were optimized and the use of materials that pollute the environment was strictly limited in 2023. In terms of consumable products, sponges were reduced based on R&D and innovation to reduce the waste generated at the end of the product's lifecycle.

By the end of the Reporting Period,



the number of models met RoHS

23,804



the number of models passed the REACH-based testing

23,366

With respect to green technology patents, we developed the "new trigger toner cartridge", which has been certified as a "High-quality Product" of Guangdong Province for its advantages of high developer utilization, low plastic content in consumable parts, and ease of use, and for which we have obtained three invention patents. Meanwhile, we developed the "cartridge without a charging roller" in the same year, which reduces high-density rubber in the toner cartridge products by 30% and achieves the same printing quality as the original. In regard to plastic reduction, the proportion of plastic in our e-commerce bottle series was reduced by 49% compared to the same model. Assuming their shipment quantities remain consistent, it is expected that the plastic waste of the former will reduce by approximately 300 kg annually. Currently, we are developing a "toner cartridge without a clean squeegee", which can reduce polymer materials by another 20% and is in the testing stage.



8.1.3.3 Green product certification

We focus on establishing a sustainable system of products and solutions that can minimize the environmental impact of the product lifecycle. We are committed to technological innovation in energy efficiency, prioritizing the use of green materials and avoiding the use of toxic chemicals to ensure human health and safety. Meanwhile, we endeavor to maximize the use of recycled components in product design to reduce resource waste. Additionally, we strictly conform to domestic and international laws and regulations for green products, covering all processes from production to use to ensure that our products satisfy environmental standards. Several product series from our subsidiaries have received environmental protection certifications, such as the "China Environmental Labeling Certification", "IECQ QC080000", the "Nordic Swan Ecolabel License", the "ENERGY STAR" standard, and the certification of the "Forest Stewardship Council (FSC)", highlighting their outstanding performance in low toxicity, low hazardous emissions, and resource conservation. These certifications not only strengthen our product competitiveness but also reinforce customers' trust in our products.



Additionally, in order to assess and manage the environmental footprint throughout the product lifecycle, we conducted the Life Cycle Assessments (LCAs) over our products with reference to ISO 14040 and ISO 14044, covering all phases, such as product design, manufacturing, distribution, use, and end of lifecycle. We also developed and implemented an HSF management system to manage the entire process from design and supply chain to product recycling.

Sharing of data on green product certification

By the end of the Reporting Period, among the Ninestar products on sale



the number of products obtained domestic authoritative environmental protection certificates (e.g. China Energy Conservation Certification and the China Environmental Labeling Certification)

10,714



the number of products obtained foreign authoritative environmental protection certificates (e.g. the Nordic Swan Ecolabel License and the ENERGY STAR standard)

24,550

8.1.3.4 Enhance product service life

In adherence to the principle of reuse, we incorporate the design concept and feature of multiple uses in our products, such as easy-to-refill products, high-capacity toner cartridge products, and continuous-delivery ink cartridges, to reduce production cost, cut resource waste and waste generation, and improve the reuse rate of products or components.



Unismart device contributes to green goals: Attaching equal importance to eco-friendly materials and high performance

In response to the national strategies of carbon neutrality, energy conservation, and emission reduction, we continue to upgrade and optimize products and devices. The Unismart device, as an innovative green product, is designed in line with the principles of no toxicity and harmlessness. All hardware is made from eco-friendly materials and the device has passed environmental protection standards, such as the European Union REACH and RoHS. Concurrently, we attach importance to lightweight materials, greatly reducing the weight of parts and structures and enhancing its overall mobility and operational efficiency.

The Unismart device is applicable to such scenarios as inspecting consumable chip data, judging chip quality, and displaying the model number, thanks to its integration in chip inspection, upgrade, burner, and reset. Based on the reuse of consumable chips, the device can not only solve customers' inventory issues and save transportation, management, and procurement costs but also reduce the recycling cost of consumables and alleviate the environmental pollution of electronic waste.



We conscientiously select high-quality raw materials, keep studying components' service lives and product maintenance, and strive to improve product durability while constantly optimizing product design for ease of repair and upgrading and reducing disposal and replacement. The imaging system of Pantum printing devices adopts dual-component imaging techniques, which can print up to 60,000 pages and reduce the product replacement cycle. Parts and components with a higher service life, such as ceramic sheets, fixing films, high-service-life organic photoconductors (OPC), and developer rollers, are applied to new product projects to raise the service lives of products, reduce carbon emissions, and save raw materials and energy required for new product production and marketing.

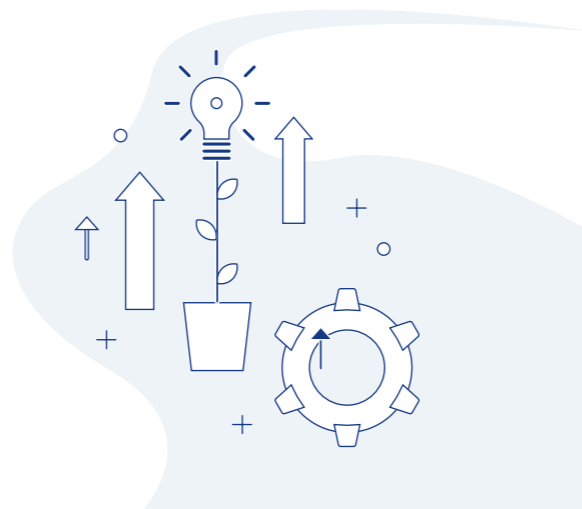

Pantum's green practices in original consumables

Pantum offers consumers a green printing experience with its high-quality products and innovative technologies. In terms of the use of original consumables, Pantum selects high-quality carbon, high-quality cartridge chips, and eco-friendly rubber parts to ensure a high transfer rate and firm fixing, reduce leakage, loss of powder, and fugitive powder, as well as prolong the service life of the printer. Meanwhile, the simple and convenient installation of original consumables greatly improves the user's operation and experience. These green practices not only strengthen the product's value, but also contribute to environmental protection.



Geehy launched an application solution for the APM32F411 dedicated outdoor air system

The dedicated outdoor air system industry is rapidly advancing and is driven by carbon peaking and carbon neutrality. In response to the demand for bi-directional flow motor control for dedicated outdoor air systems, Geehy has launched an application solution for the APM32F411 dedicated outdoor air system. The solution adopts non-inductive field-oriented control (FOC) and a dual resistance sampling mode to control both the inlet and exhaust fans of the dedicated outdoor air system. Characterized by large storage capacity and a high-performance processor, it can effectively reduce energy consumption and improve the energy-saving performance of the system. Meanwhile, Geehy's dual-motor control solution supports the inductive control mode. Its high-precision chip facilitates precise motor control. It can be widely applied to balance cars, gate machines, electric vehicles, and washing machines.

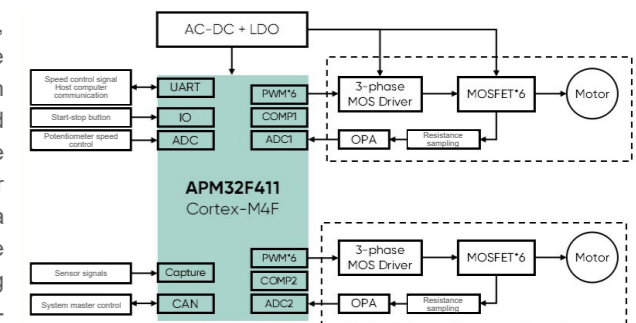

8.1.3.5 Green production

For production, we always adhere to green production. During product production, we consider all environmental factors, utilize advanced production equipment and technology, and enhance production efficiency and product quality. Meanwhile, we keep optimizing production processes and reducing energy consumption and waste emissions. For details, see Section 8.3 Energy management.

Concurrently, several of our subsidiaries have been ISO 14001 certified. Environmental management has been incorporated into routine operations and strategic planning to ensure that environmental factors can be fully considered. Furthermore, we encourage organizations to constantly seek opportunities to improve their environmental performance. By promoting green supply chain management, we require suppliers to comply with environmental standards and use state-of-the-art energy-saving technologies and processes to meet efficient technology requirements, reduce waste, conserve resources, and reduce emissions, thereby reducing adverse environmental impacts. Moreover, we ensure that organizations observe applicable



laws, regulations, and other environmental requirements to avoid legal risks and financial losses due to environmental issues. Meanwhile, we effectively communicate with our stakeholders (e.g. customers, suppliers, and communities) on environmental issues to gain trust and cooperation.

8.1.3.6 Carbon footprint certification

During product design and manufacturing, we stress the importance of sustainable development. Actions are earnestly taken in carbon footprint certification to provide more eco-friendly and energy-saving products. In particular, Pantum's 5103 model, as one of the most representative products, features high energy efficiency and a low carbon footprint and has been certified by the British Standards Institution (BSI) for its carbon footprint based on optimized hardware configuration and software algorithms. This certification not only demonstrates our technological strength in the printer industry but also recognizes our commitment and effort to reduce greenhouse gas emissions throughout the entire lifecycle of our products. We will continue to increase R&D investment and gradually raise the proportion of products with carbon emissions certification. We will also continuously optimize our product lines and further reduce carbon footprint through technological innovation and procedure improvement.

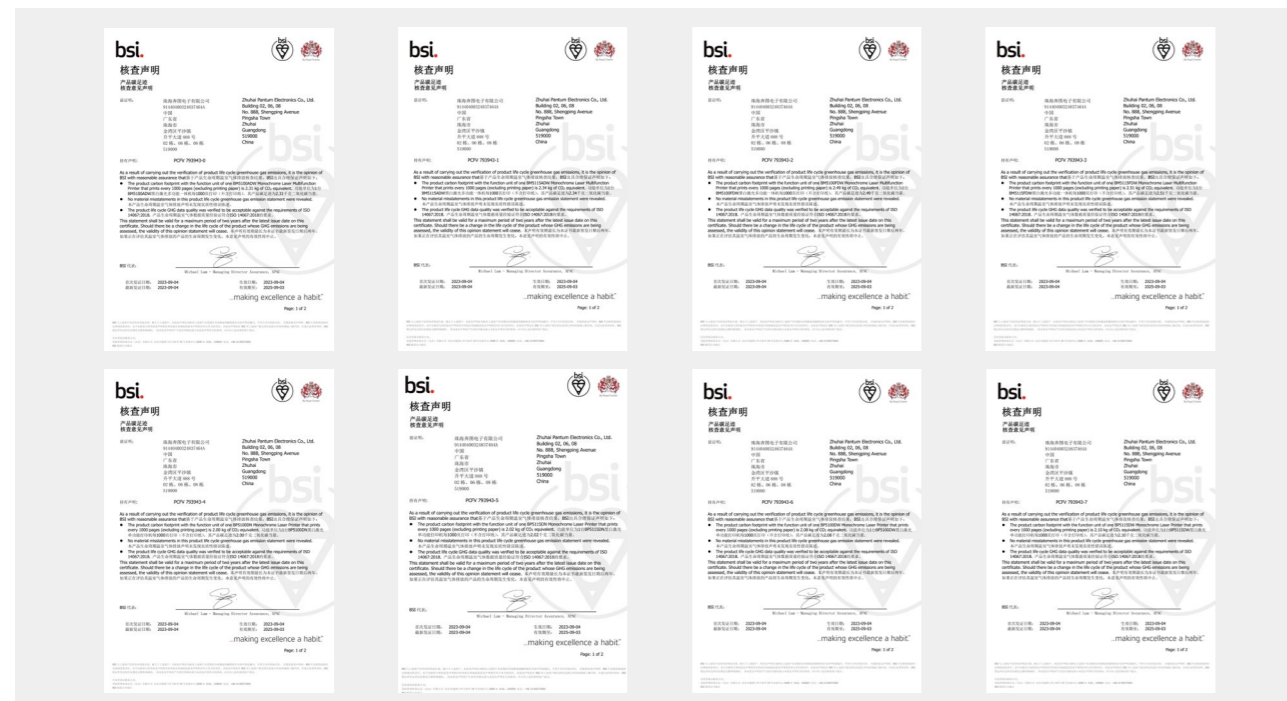

8.1.4 Indicators and objectives

Objectives

- To use recyclable plastic packaging and eco-friendly packaging materials
- To reduce the use of packaging cartons
- To use renewable materials for shipping cartons
- To use eco-friendly inks
- To use biodegradable ink labels
- To optimize product design
- To design products with zero surplus ink
- To remove non-biodegradable materials
- To provide users with perfect experience

Annual progress

All our products are packaged and sold in recyclable plastic bags made from polyethylene terephthalate (PET) and polyethylene (PE). Our plastic bags are mainly made from materials in line with environmental protection standards, such as oriented polypropylene (OPP), OPP + cast polypropylene (CPP) composites, polyolefin (POF), and PET. Our commonly used carton materials include, but are not limited to, recycled materials such as 350g gray cardboards, B9 corrugated boards, and K9 kraft papers, with a total proportion of **50%**.

Statistically, **90%** of our products sold in Japan do not use outer cartons.

Our sustainable shipping cartons are made from **100%** renewable materials and are glued with eco-friendly glue rather than copper nails, so they can be **100%** biodegraded.

Statistically, **90%** of our ink bottle labels are made from self-adhesive paper and varnish, so that such labels are **100%** self-degradable and plastic-free.

Large ink bottles are used to greatly reduce the frequency of replacement of consumables. Printers with **zero surplus** ink are designed to minimize the environmental pollution caused by inks.



8.2 Electronic waste recycling

8.2.1 Concept

As a responsible producer, we vigorously advocate and practice the philosophy of electronic waste recycling. Effective measures are taken to ensure proper treatment and recycling of used printer products and reduce the negative impact of electronic waste on the environment.

8.2.2 Strategies

Through the product recycling system, we recycle and reuse electronic waste in our global operations. For instance, we actively promote the recycling of ink cartridges and toner cartridges, screen, classify, and carefully clean them, and then refill them into reusable consumables to ensure the efficient use of resources and the reduction of environmental pollution and achieve both economic and environmental benefits.

8.2.3 Actions and practices

8.2.3.1 Cooperating with the industry network to perfect electronic waste recycling procedures

In China, our electronic waste recycling system is being perfected. Clear instructions are given on how to dispose of electronic waste in the user manuals of our products so that users can follow the instructions to dispose of their electronic waste properly. Upon collection, we hand scrapped products over to qualified third-party organizations to ensure proper recycling, save resources, and reduce environmental risks.

Overseas, we cooperate with local third-party agencies to register waste electrical and electronic equipment (WEEE) into the local recycling system to ensure that scrapped products can be effectively recycled in different regions, further promoting the recycling system of electronic waste that covers the global business. In order to further improve customer experience and advocate environmental protection, we provide special recycling bags for consumables. Users can simply put the empty consumables into the disposal bags after use for unified recycling.

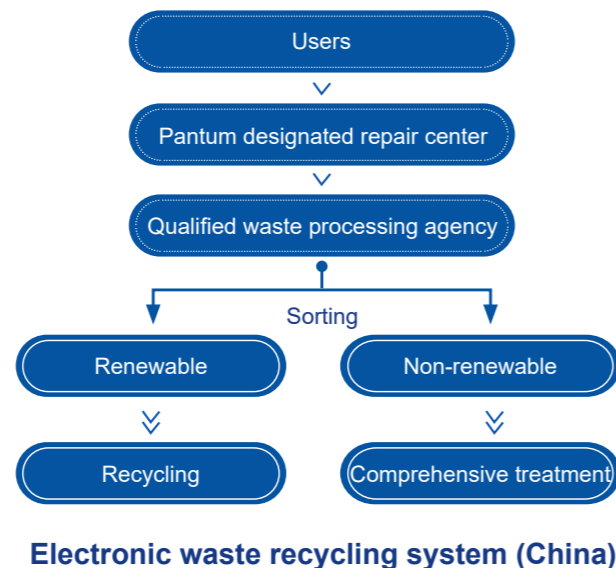

8.2.3.2 Implementing recycling programs

We push forward the philosophy of green environmental protection and actively implement product recycling programs to reduce the negative impact of electronic waste on the environment. We also advocate and encourage users to participate in the recycling of scrapped products. In order to simplify the electronic waste recycling procedures and further promote the electronic waste recycling programs, we have launched an ink cartridge recycling program in various regions around the world where we operate, covering more than 30 countries and regions, such as China, Japan, the United States, and European countries, and a number of well-known brands. Additionally, we have added channels for recycling by mail year by year. It is expected that approximately 10 tons of electronic waste can be recycled annually.

Through product leaflets and recycling slips in product packages, we introduce the environmental characteristics, recycling methods, and post-recycling treatment procedures of our products to users so as to raise their awareness of green consumption. Meanwhile, efforts have been made to formulate operational procedures for the recycling applet to provide users with recycling guidelines and gradually cultivate their habit of green consumption. During recycling, we not only do not charge users any fees but also offer them coupons or cash rewards. Consumers who have put relevant waste into the supermarket's recycling machine can receive a coupon from the supermarket, which can be used as a cash discount on their purchases.



G&G leads a new environmental protection trend: Cartridge recycling for environmental protection and full coverage of toner cartridge recycling services

Since its establishment, G&G has been committed to providing quality products and services. We have launched the "Going Green" (overseas) and the "Flashback Recycling Program" (domestic) for ink cartridge recycling to help users recycle and dispose of empty and used ink cartridges, effectively reduce environmental pollution, and benefit the circular economy.

During the Reporting Period, we officially launched the toner cartridge recycling service to help users dispose of empty and used toner cartridge products. The service covers all toner cartridge models, including filled and unfilled products with intact appearance and without powder leakage. At present, it mainly covers Beijing, Tianjin, Hebei, Shandong, Shanghai, Hangzhou, Ningbo, Nanjing, Suzhou, Wuxi, Guangdong Province, Jiangxi Province, and Hunan Province. Customers with recycling needs can hand over their toner cartridge products to their local dealers. The latter will submit an order to the service provider after accumulating a certain number of ink cartridges. The service provider will then recycle them door-to-door after accepting the order. Recycled toner cartridge products will be placed horizontally or vertically in a uniform way. Each layer will be separated by a cardboard. The carton will be sealed with a box mark. Only after the pallet mark is separately affixed to the pallet can recycled products be shipped. Upon recycling, the branch will reconcile and settle with the dealer and the service provider. This ensures the effective management and disposal of used toner cartridges. For other regions with recycling needs, you can contact the headquarters in Zhuhai. We will directly send them back to the G&G plant for treatment after they accumulate to a specified quantity.

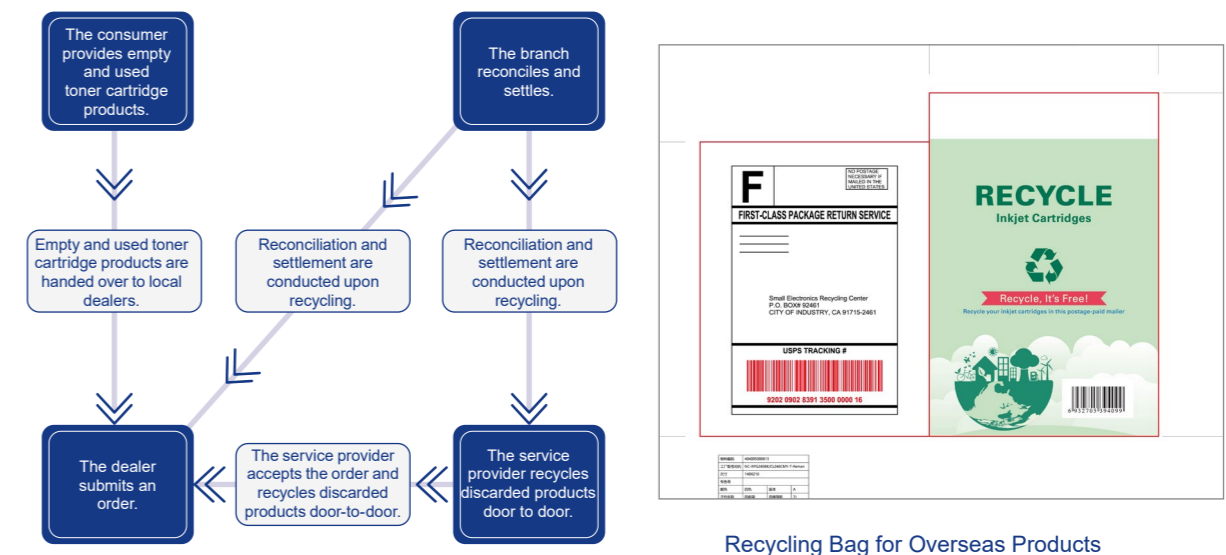

8.2.3.3 Expanding channels and scope of recycling

In order to improve recycling efficiency and motivate users to participate in recycling, we recycle products through multiple channels. The main collection channels include but are not limited to:

Recycling at designated locations

In selected locations where we operate, we cooperate with recyclers or dealers to set up recycling bins in stores or designated recycling points. Users can put the used products into the recycling bins, which will be recycled by the recyclers or handed over by the dealers to a processing agency with relevant qualifications.

Recycling by mail

We set up electronic waste recycling programs and accept end-of-life products sent by mail. We have launched the "Mailing Bag" Program. For some program, we place recycling bags in product packages to encourage users to send back discarded products. End customers can also send them directly to the plant warehouse via the applet. Taking ink cartridges as an example, users can put the used ink cartridges in the mailing bag and return them to the Company via local postal services. We then hand over the discarded products to qualified third-party agencies for proper treatment to achieve product recycling and reuse.

Recycling and disposal program

We work with local agents and recyclers in the exporting countries of our original products as well as the sales areas of other brands, such as Canon and HP, to recycle discarded consumables.

8.2.3.4 Recycle and reuse

To reduce electronic waste pollution and improve the efficiency of electronic waste recycling, we have developed a cartridge recycling program to recycle empty laser powder cartridges through our own recycling plant, and at the same time, we clarify, track, and record the process of dismantling, cleaning and utilization, recycling, and treatment of electronic waste to ensure that the whole process is carried out in facilities that comply with local laws and regulations.

We process materials that can be recycled for secondary use. The Company's toner cartridge recycling center boasts industry-leading toner cartridge recycling and remanufacturing technologies and processes, enabling the reuse of waste toner cartridge parts to make recycled toner cartridges.

For the materials that cannot be recycled for the time being, we transfer them to an organization with waste disposal qualifications for recycling, reuse and disposal in order to save resources and reduce environmental pollution.

For the precious metals in electronic waste (mainly copper and gold), we use chemical extraction methods. This approach ensures safe disposal and promotes local recycling of electronic waste.

In regard to recycling and reuse, we recycled approximately 19,534,000 toner cartridge products and ink cartridges in 2023, effectively reducing waste generation and extending product service life. At present, we can recycle 1,331 product models and will expand the range of recyclable product models to cover more types of products.

G&G set recycling objectives for ink and toner cartridge products and fulfilled its commitment to sustainable development

G&G, as an industry-leading ink cartridge remanufacturer, has been committed to reducing consumable waste and extending the service life of ink cartridges since 2000. In honor of Global Remanufacturing Day, G&G has set a new recycling objective—to recycle 120 million ink and toner cartridge products from January 2021 to October 2024 to demonstrate its commitment to a more sustainable printer industry.

In order to achieve this objective, G&G has planned to deepen its cooperation with recyclers to ensure the reliability of sources of discarded ink cartridges and will continue to encourage customers to mail used ink cartridges back to us through its "Going Green" (overseas) and the "Flashback Recycling Program" (domestic). It is expected that this objective will save 842 million new parts from being manufactured and reduce carbon dioxide emissions by at least 3,588.31 tons, equivalent to planting 163,000 trees.

8.2.3.5 Recycler audit

The qualifications of our recyclers and waste treatment agencies are reviewed based on a strict partner screening mechanism, including the risk assessment of business procedures, assessment of internal control systems, and compliance inspection of recycling partners to ensure that they have the relevant business licenses of the places where we operate and have comprehensive WEEE treatment facilities and equipment, so as to enhance the transparency and efficiency of the entire supply chain.

During the Reporting Period

we completed the annual audits of

3

recyclers



8.2.4 Indicators and objectives

Objectives

- The recycled materials will account for more than **25%** of the materials for ink cartridge products within the next three years.
- To expand the recycling network to **30** countries and regions worldwide to ensure effective recycling of electronic waste globally
- To achieve an average annual growth of **20%** in recycled electronic waste over the next five years
- To provide employees with training related to electronic waste recycling to ensure that they understand and practice the correct recycling procedures and treatment methods
- To assist G&G in completing its cumulative recycling objective of 120 million consumables

Progress

- The electronic waste recycling procedures were improved.
- Approximately **19,534,000** products (e.g. toner and ink cartridges) were recycled in 2023.
- We continuously promoted industry network cooperation and cooperated with local recycling networks around the world.



8.3 Energy management

8.3.1 Philosophy

Upholding the innovation-driven principle, we enhance energy efficiency, reduce energy consumption and carbon emissions, and achieve green and sustainable energy management, by optimizing the energy structure and energy-saving technologies.

8.3.2 Strategies

Ninestar actively responds to the call for energy conservation and emission reduction, strictly abides by the Energy Conservation Law of the People's Republic of China, the Cleaner Production Promotion Law of the People's Republic of China, the Administrative Measures for Industrial Energy Conservation and other laws and regulations. We have formulated management policies, such as the Management System for Electricity Safety in Factory Workshops and Offices and the Electricity Consumption Assessment and Management Provisions, revised the Setting and Use Specifications for Central Air Conditioners/Cabinet Air Conditioners/Ceiling Air Conditioners, and actively proposed new technologies for energy conservation and emission reduction to achieve efficient and green use of energy.

8.3.3 Actions and practices

8.3.3.1 Scientific use of energy

During the Reporting Period, we managed energy from the following perspectives:



Energy-saving renovation of equipment

- The traditional lighting fixtures in offices, dormitories, and parking lots were replaced with energy-saving lamps, and lighting hours were controlled by voice and motion sensors.
- The operation of air compressors was optimized through the joint control of multiple air compressor units.
- Energy-saving renovation was carried out over the intelligent temperature control system for cooling water.
- Energy-saving renovation was carried out over the intelligent temperature and humidity regulation and monitoring system for workshops.
- The project of electricity consumption and energy storage of industrial parks was launched.



Energy-saving control of equipment

- The temperature of the central air-conditioning system was set to the energy-saving mode of 26°C. The start and stop of air conditioners were controlled based on working hours and weather. Wall-mounted fans were installed in the dining area for rapid cooling and effective energy conservation.
- Employees were encouraged to participate in air-conditioning power-saving initiatives. Power-saving measures, such as turning off office power during lunch breaks on workdays and turning off lights before leaving, were implemented.
- The control over air compressors was improved, and their output pressure was adjusted to around 0.6 Mpa. Additionally, the air leakage issue in the workshop was remedied. The available time for air compressors was adjusted based on the workshop's air consumption pattern to avoid no-load operation.
- The original water pump was replaced with an inverter servo. A looped network of cooling water supply was used to enhance the efficiency of the cooling water pump.



Regulatory policies and measures

- Management policies, such as the Office Water and Electricity Management Regulations and the Workshop Electricity Consumption Regulations, were formulated to standardize the use requirements of large equipment and lighting fixtures.
- The monthly electricity consumption reduction per product in the workshop and of air compressors was assessed to supervise and improve the management of energy conservation and consumption reduction.
- An energy management system was adopted. The input and output of the joint control of multiple air compressor units were tracked via the accounting table to achieve real-time monitoring and effective control of energy consumption.



Promotion and implementation of energy conservation and emission reduction

- Online working was encouraged to reduce unnecessary business travel.
- Carpooling was advocated to reduce the use of official vehicles.
- Shuttle buses were available for employees to promote public transportation and reduce the use of private vehicles.
- Monthly employee meetings were held to promote energy and water conservation and reuse of office paper.
- Training related to green office, low carbon emissions and environmental protection, resource conservation, and waste classification was organized.
- Energy-saving tips and guidelines were pasted on air conditioners and light switches, to cultivate the habits of keeping the air-conditioning temperature no lower than 26°C and turning off lights before leaving.



Data collection and processing through the energy management system

We have established an energy management system with a hierarchical distributed structure for centralized supervision of energy, such as electricity, gas, compressed air, coal, diesel, and water. The energy management system is characterized by cross-platform operation, coverage of multiple energy sources, unified management of the Group, and rich experience in the industry, and has features such as real-time energy monitoring, comprehensive statistical analysis of energy consumption, and energy quality management and control. By collecting, processing, and analyzing energy consumption data, we can understand energy use in real-time to formulate the corresponding energy consumption plan and promote low-carbon development.



Structure of the Energy Management System



Screen of Real-time Monitoring
Calendar Analysis of Energy Consumption

8.3.3.2 Using clean energy

We strongly promote the use of clean energy to help save energy and reduce emissions. We have adopted solar technology since 2018 and have installed 12,000 square meters of photovoltaic (PV) panels so far. Up to 300,000 kWh of electricity can be generated per month in sunny weather, equivalent to the environmental benefits of planting 1.2 million trees. Furthermore, we vigorously drive photovoltaic power generation equipment projects through technological innovation and plan to build anew 3 MW rooftop PV project in Nanping Park in Zhuhai by 2024. During the Reporting Period, we completed the construction of a photovoltaic power generation equipment plant in Pingsha Park in Zhuhai. A new 6 MW rooftop PV project in Hefei Park is about to be put into operation. We purchased new energy vehicles (NEVs) for short-distance travel and cargo delivery in the city to reduce gasoline usage. Meanwhile, we installed solar water heating systems in employee dormitories to reduce the demand for heat from the power grid.

Using clean energy to power the plant

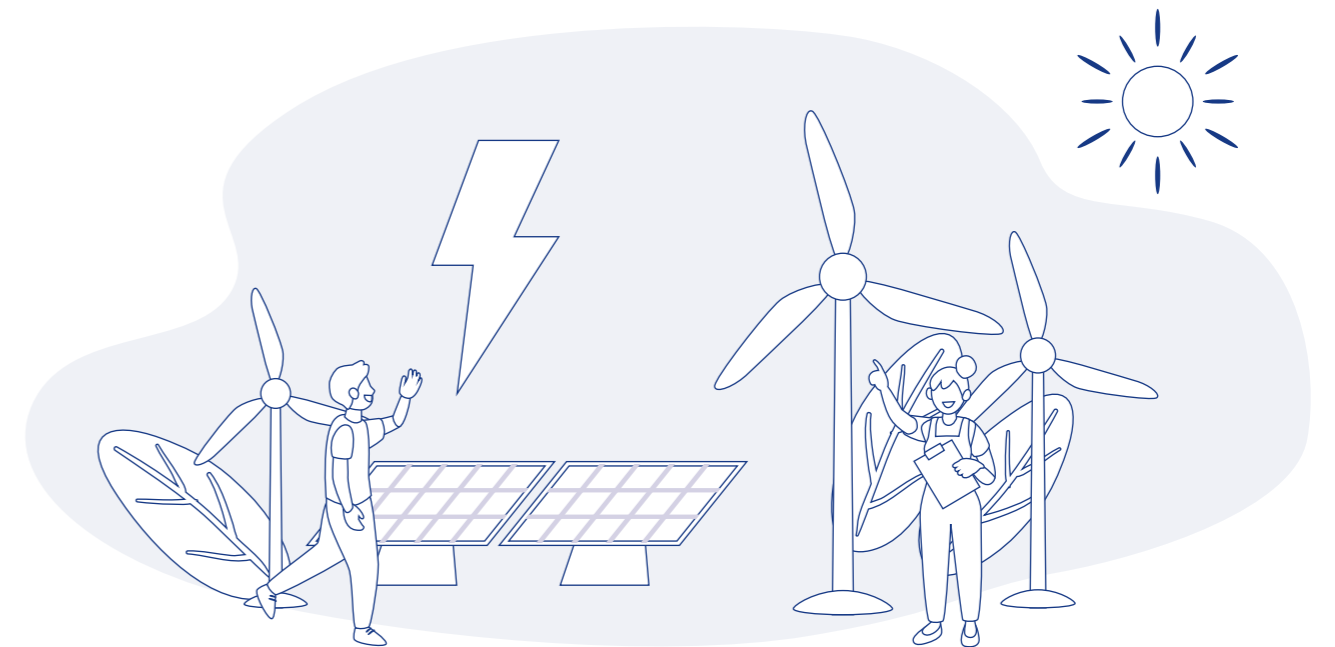

Data on the use of clean energy

- The photovoltaic power generation in 2023 amounted to 2,156,389 kWh.
- Three NEVs were purchased for official use.
- Approximately 620 tons of water was heated for employee dormitories with solar energy.

ESG Indicators	Unit	Data in 2023
Outsourced electricity usage	10,000 kWh	4,509.35
Photovoltaic power generation (self-use)	10,000 kWh	215.64
Gasoline usage	Liter	75,609.14
Diesel usage	Liter	37,395.75
Total energy consumption	Ton of standard coal equivalent	5,935.34
Direct energy consumption	Ton of standard coal equivalent	393.35
Indirect energy consumption	Ton of standard coal equivalent	5,541.99
Comprehensive energy consumption intensity	Ton of standard coal/CNY10,000 of revenue	0.0025
Direct greenhouse gas (GHG) emissions (Scope 1)	tCO2e	269.46
Indirect greenhouse gas (GHG) emissions (Scope 2)	tCO2e	25,716.80
Total greenhouse gas (GHG) emissions	tCO2e	25,986.26
Greenhouse gas (GHG) emission intensity	tCO2e/CNY10,000 of revenue	0.0108



The plant rooftop photovoltaic power station project of the Ninestar Pingsha Industrial Park in Zhuhai

The construction of the rooftop photovoltaic power generation equipment station project in our printer industrial park began in August 2023, covering approximately 80,000 square meters of rooftop area. With a maximum installed capacity of approximately 9.6 MW, it operates on the mode of "self-generation and self-consumption, surplus for the grid". The project is expected to generate 9 million kWh of electricity annually.

The PV panels act as an insulating layer in summer, can effectively lower the indoor temperature by around 3°C, and convert solar power into clean electricity for plant production. Under good natural lighting conditions, the power generated by the project can fully meet the daytime electricity needs of the plant. Statistically, approximately 2,700 tons of standard coal can be saved, and 7,237 tons of carbon dioxide can be reduced annually, equivalent to planting 395,000 trees. In short, this project reduces our electricity costs, improves energy efficiency, and promotes green, low-carbon, and circular development.

8.3.4 Indicators and objectives

Objectives

- To establish an energy monitoring system to realize real-time monitoring and precise analysis of plant energy consumption
- To replace old air compressors with high energy consumption to promote energy efficiency and emission reduction
- Optimize the cooling tower system and pump configurations to improve energy efficiency
- Enhance temperature, humidity, and refrigeration controls to conserve water, electricity, and gas and reduce energy consumption

Annual progress

- The energy monitoring system provides accurate hourly monitoring data to precisely identify energy waste and aspects for improvement.
- A new 55 kW air compressor was purchased to replace the old one with high energy consumption, reducing overall energy consumption by **39%**.
- The cooling tower was replaced, and the placement and pump head were adjusted, thus reducing the pump power by **51%**.
- The central air-conditioning system was optimized to provide constant temperature and humidity for areas with temperature and humidity requirements and implement separate cooling control in other areas.



8.4 Emissions management

8.4.1 Philosophy

We are keenly aware of the importance of emissions management and strictly adhere to the requirements of relevant national laws and regulations. Through technological innovation, process optimization, and effective management practices, we endeavor to reduce the generation of exhaust gas emissions, wastewater, and solid waste at the source. We are committed to emissions reduction and continuously strive to optimize and implement various environmental protection measures based on feedback from government agencies, society, and stakeholders.

8.4.2 Strategies

We have established and continuously refine the Safety Operation and Maintenance Regulations for Sealed Drum Recycling Organic Exhaust Gas Treatment Equipment, Safety Operation and Maintenance Regulations for Exhaust Gas Treatment Equipment, Wastewater Discharge Regulations, Safety Operation and Maintenance Regulations for Sewage Treatment, and Guidelines for Waste Classification and Treatment. These measures enhance employees' safety awareness and emergency response capabilities in handling emissions, ensuring compliance and safety.

8.4.3 Actions and practices

8.4.3.1 Exhaust gas treatment

Our exhaust gas emissions primarily stem from laser coding exhaust gas, powder filling dust, and kitchen fumes. We strictly adhere to the emission standards outlined in the Limits for Atmospheric Pollutants Emissions, specifically for particulate matter dust and organic emissions (benzene and toluene emissions). We collect dust-laden exhaust and benzene/toluene emissions, which are then purified through dust removal systems before being discharged into the atmosphere at high altitudes. For hazardous waste such as waste carbon powder and spent activated carbon, we adhere to relevant environmental regulations to ensure compliant disposal. For kitchen fumes and other exhaust gases, we employ purification treatment devices to ensure emissions meet regulatory standards.



In 2023, our actual dust emissions were under 4 mg/m³, resulting in an annual reduction of

4.3 tons

8.4.3.2 Solid waste treatment

We strictly adhere to the laws and regulations of the Law of the People's Republic of China on Prevention and Control of Environmental Pollution by Solid Waste and General Industrial Solid Waste Storage and Landfill Pollution Control Standards for pollution control on the non-hazardous industrial solid waste storage and landfill. We have established management policies such as Waste Classification and Disposal Regulations, Pollution Prevention Procedures, and Emissions Management Regulations. Additionally, in accordance with HJ1276-2022, we have implemented standardized signage at storage sites to further enhance environmental awareness among all staff, promoting waste reduction and harmlessness and reducing the environmental impact of waste.



Posting Standard Waste Disposal Signage at Storage Sites

8.4.3.3 Hazardous waste treatment

Our operational hazardous waste includes waste packaging drums, waste paint, waste carbon powder, waste ink, and waste ribbons. We classify and properly dispose of all untreated hazardous waste in accordance with relevant regulations, and transfer them to qualified hazardous emissions management companies for disposal.



The disposal rate of hazardous waste for this year was

100%

8.4.3.4 Non-hazardous waste treatment

Our non-hazardous waste primarily includes recyclable waste such as used paper and non-recyclable waste such as household garbage and kitchen waste. For recyclable non-hazardous waste, we conduct specialized training on waste sorting, follow the guidelines for household waste classification during collection, and entrust qualified third-party organizations to handle transportation, recycling, and disposal. We conduct quarterly on-site audits of waste recycling companies and other third-party organizations annually to ensure compliant emissions management. For non-recyclable waste, we dispose of it uniformly within the operational area in accordance with local regulations. Qualified third-party organizations are contracted to handle transportation, recycling, and disposal as per the contractual requirements.

8.4.4 Indicators and objectives

Objectives

- Optimize production, transportation, and sales processes to reduce the generation of hazardous waste
- Improve production processes to reduce the discharge of pollutants
- In 2024, will optimize our dust removal system to enhance the efficiency of air purification

Annual progress

- We reviewed and optimized the production, transportation, and sales processes, and developed and implemented measures to reduce the generation of hazardous waste, such as improving packaging
- We promoted improvement projects in production processes, focusing on technological innovations that reduce pollutant emissions
- We advanced the development and implementation of optimization plans for the dust removal system, with the goal of completing system upgrades and verifying improved purification efficiency by 2024

8.5 Water resources management

8.5.1 Philosophy

We emphasize the conservation and protection of water resources. Upholding the philosophy of sustainable development and strictly complying with the laws and regulations, we have enhanced the efficiency of water resources in our daily operations through the adoption of advanced water-saving technologies and management methods.

8.5.2 Strategies

Strictly abiding by the Water Law of the People's Republic of China, the Water Pollution Prevention and Control Law of the People's Republic of China, and the Environmental Protection Law of the People's Republic of China, we have formulated management policies including the Environmental Management Policies, the Energy Management Regulations and the Wastewater Discharge Management Regulations of the Consumables Business Unit to clarify the environmental management structure and responsibilities and to standardize the concentration ink collection requirements. We have strictly implemented GB25463-2010 Discharge Standard of Water Pollutants for Printing Ink Industry, carried out hierarchical control of industrial wastewater at source to reduce the impact of fluctuations in wastewater concentration on the wastewater treatment process, and realized the sustainable use of water resources by means of effective water-saving measures, rational water resource planning, and highly efficient wastewater treatment solutions.

8.5.3 Actions and practices

8.5.3.1 Management and promotion

During the Reporting Period, we conducted the management and promotion of our water resources in the following ways:

- We ensure that wastewater meets the requirements of GRI 303 standards by sampling effluent on a regular basis, introducing testing equipment and monitoring indicators such as pH, COD, and ammonia throughout the year.
- Water-saving slogans and posters are displayed to enhance the water-saving awareness of all employees, ensuring that people turn off the faucet after leaving to avoid the occurrence of "long-term water flow".
- The Safety Committee Office periodically conducts random inspections of the workshop's water usage to eliminate the waste of water resources. In accordance with the requirements of the discharge permit, the treated water is tested by an external qualified monitoring organization to ensure that the water quality is above the national discharge standard.
- We adopted a constant-pressure water supply system that divides the water supply into high and low zones to meet the water needs of the residential staff during the morning and evening peak periods.
- We have arranged for specialized personnel to supervise and manage the water use in the park and regularly monitor the water meter usage to report it for maintenance in a timely manner while finding water leakages, thus avoiding the waste of water resources.
- We conduct full disinfection cleaning and testing of domestic water tanks once a year to ensure safe water quality.

8.5.3.2 Wastewater recycling

We recycle water in the following ways:

- In accordance with GB25463-2010 Discharge Standard of Water Pollutants for Printing Ink Industry, we set up wastewater treatment facilities and adopted a well-proven A²/O process to treat industrial wastewater and domestic wastewater. The wastewater is discharged through the pipeline network into the water purification plant for further treatment after pre-treatment and comprehensive treatment.
- We invested CNY9,042,800 to build our own sewage treatment station in the park, which covers an area of 1,500 square meters and treats 180,000 tons of sewage per year.
- We have expanded the wastewater treatment plant in the park. For the production wastewater generated from cleaning and recycling cartridges and manufacturing ink, professional wastewater treatment engineers are in charge of analyzing water quality every four hours to ensure that the wastewater meets the standards of treatment and the wastewater is recycled for irrigation and toilet flushing in the park.
- Municipal water is filtered through a filter before flowing into a domestic water tank, which is equipped with a disinfection device. The water is then pressurized and supplied to various departments and residents for use.
- We recycled the cooling water of the injection molding machine and wastewater from wastewater treatment stations to reduce water consumption.
- We designed and built sponge city systems in our two major industrial parks to recycle and reuse rainwater and improve the efficiency of water utilization.





Lexmark's bioresources and rainwater harvesting system in Kentucky

Lexmark has joined forces with Lexington-Fayette Urban County Government (LFUCG), EcoGro, Ridgewater, Stantec, and the University of Kentucky to launch an innovative bioresource and rainwater harvesting system in Lexington, Kentucky. The system exceeds the size of Lexington's three traditional rainforest gardens but has features similar to these gardens. Bioresource basins, on the one hand, filter rainwater through sand and reserve water not needed for immediate use. On the other hand, they act as retention basins for slowing down rainfall runoff in the event of excessive discharges to the creek. Natural soft water is used in Lexmark's cooling towers, reducing the need for chemical treatment of the water.

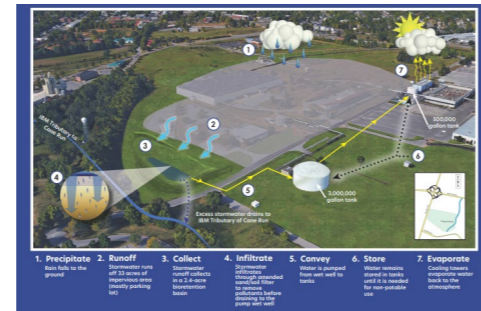

Schematic Diagram of the Operation of the Bioresources and Rainwater Harvesting System

This bioresource and rainwater harvesting system was honored with the 2021 International Green Apple Award, the 2020 Manufacturing Leadership Sustainable Development Award, and the 2019 Wastewater and Stormwater Award from ACEC-KY. This project not only brings environmental and economic benefits to the local community but also provides a successful example of rainwater harvesting and resource utilization for other cities and companies.

8.6 Response to climate change

According to the Global Risks Report released by the World Economic Forum (WEF), climate-related environmental issues are among the top four risks of the top ten global risks over the next ten years, including failure to mitigate climate change, failure to debug climate change, natural disasters and extreme weather events, and biodiversity loss and ecosystem disintegration. Adapting and proactively responding to the risks and opportunities of climate change is a requirement for companies to strengthen their climate resilience management.

As the world's leading printer manufacturer, we are fully aware of the importance of climate change and its far-reaching impact on our business operations and long-term value. We have been actively responding to China's goal of carbon peaking and carbon neutrality to strengthen our ability to address climate change. During the Reporting Period, we continued to deepen our understanding and management of climate change risks and opportunities through the four pillars of Governance, Strategy, Risk Management, and Indicators and Objectives in line with the recommended framework of the TCFD. We are committed to reducing the impact of climate risk by improving our governance structure, promoting low-carbon manufacturing, increasing the use of renewable energy, and improving energy efficiency.

In the future, we will further improve our climate risk and adaptation analysis under different climate scenarios, better identify and respond to climate risks, strengthen our climate risk management, and promptly seize the opportunities brought by climate change.

8.6.1 Philosophy

We have established a two-tier governance structure of the ESG Committee - ESG Project Team and have integrated climate change issues into its management responsibilities to ensure that we have an effective governance structure for climate-related risks and opportunities, from the strategic level to the executive level.

The ESG Committee is the strategic level of ESG governance and is responsible for setting the overall strategic direction and overseeing the management of climate risks and opportunities. The ESG Project Team under the ESG Committee is the ESG management team responsible for identifying and evaluating climate risks and opportunities and integrating them into our daily operations and long-term planning. It is also responsible for undertaking the specific implementation of the ESG management plan to ensure that climate risk management is incorporated into all business and decision-making processes. In addition, we have established specialized management organizations for energy conservation and emergency response.

Relevant performance data

Total water consumption
1,039,532.69 tons

Total water consumption intensity
0.4320 ton/CNY10,000 of revenue

Treatment of wastewater in 2023
180,000 tons

8.5.4 Indicators and objectives

Objectives

- Implement hierarchical control of wastewater discharges at source to reduce the difficulty of sewage treatment
- Strictly implement a 24-hour duty system and a 4-hour water quality testing system to ensure that sewage treatment meets discharge standards
- Maintain equipment and facilities in strict accordance with the requirements, and effectively manage the important spare parts to ensure the stable operation of sewage treatment equipment
- Switch the central air-conditioning cooling towers from traditional round towers to square towers, with estimated water savings of 2,000 tons in 2024

Progress

In 2023, a total of **1,400** tons of water was saved by the wastewater treatment improvements.



Regularly review climate risk response and opportunity assessment, and focus on climate change related strategies and objectives, such as energy saving and consumption reduction, emergency response, and climate risk assessment.

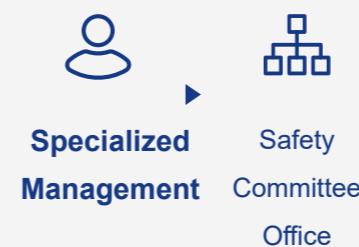

- It is organized and managed by the Company for the purpose of energy saving and consumption reduction. It monitors and sets energy-saving and emission reduction targets, analyzes and promotes optimization of production activities, and implements energy-saving and consumption reduction management.
- It is responsible for developing and implementing emergency response plans for environmental emergencies in response to sudden natural disasters. When the government issues an early warning of a natural disaster, the Safety and Environment Department would pay close attention to the level of the disaster and the extent of the hazard, and take appropriate protective measures.

8.6.2 Strategies

We understand the important impact of climate change on the global environment and economic development and are committed to realizing green transformation through climate change mitigation and climate change adaptation by setting scientific emission reduction targets and adopting a series of policies and measures, such as investing in clean energy, improving production processes, and promoting energy-saving technologies to optimize the use of resources and improve energy efficiency.



Climate change mitigation

- Increase R&D and investment in clean technology: Develop low-carbon emission printing technologies, such as the use of environmentally friendly inks and printing processes that reduce carbon emissions.
- Improve energy efficiency: Optimize printer hardware design through technological innovation to reduce energy consumption.
- Use renewable energy: Prioritize the use of renewable energy, such as solar and wind power, in the production process.
- Product life cycle management: Reduce the release of hazardous substances and the environmental impact of our products throughout their life cycle in raw material procurement, production, transportation, use and disposal.



Climate change adaptation

- Risk identification and assessment: Conduct a climate change risk assessment of our global production bases, supply chain, and businesses, identify the processes that may be affected, and formulate corresponding response strategies
- Enhance natural disaster response capacity: Strengthen infrastructure development and contingency plans to ensure the safety of production and personnel in response to natural disasters that may be caused by climate change, such as floods and typhoons
- Adjust business strategies: Adjust our business strategies in light of the impacts of climate change, for example, shifting to more environmentally friendly products and services to meet changes in market demand



8.6.3 Actions and practices

Based on TCFD's risk classification criteria, we conducted risk analysis on physical risk and transformation risk. By identifying risks, we fully recognize the potential impact of climate change on our operations and are committed to addressing these challenges through proactive strategies to ensure our continued growth.

8.6.3.1 Identification of physical risks

Classification	Category	Description of potential risks	Countermeasure
Acute	Extreme weather such as typhoons, rainstorms and hailstorms	<ul style="list-style-type: none"> • They may lead to damage to park facilities, interruption of operations, and loss of goods, affecting the normal operation of parks and factories and causing direct economic losses • They may lead to health and safety injuries for park and plant workers 	<ul style="list-style-type: none"> • Reinforce infrastructure in work zones and factories and strengthen water supply and drainage management • Develop a comprehensive emergency response plan, strengthen the meteorological warning system, emergency evacuation routes and post-disaster recovery plans, and organize hands-on training and emergency drills to ensure a rapid response • Build an emergency response system, establish emergency response organizations and responsibilities, as well as reserve emergency supplies and rescue teams
		Chronic	Increase in average temperature
	Drought		<ul style="list-style-type: none"> • It may cause water scarcity, leading to water shortages in factories, which affects normal production and thus reduces yields



8.6.3.2 Identification of transformation risks and opportunities

Classification	Category	Description of potential risks	Countermeasures
Policies and laws	Risks	<ul style="list-style-type: none"> Carbon emission restrictions: As national and regional carbon emission restrictions become more stringent, we may be required to pay higher carbon taxes or comply with more stringent carbon emission standards, which may result in higher operating costs Tighter environmental regulations: New or stricter environmental regulations (e.g., emission standards and energy efficiency requirements) may require us to invest in environmentally friendly technologies or improve operational processes, which may result in additional financial costs Tightening of compliance requirements for overseas sales: Countries and regions such as the EU and the U.S. have higher standards for climate change and product life cycle carbon emissions management, which will affect our overseas business and bring certain compliance costs 	<ul style="list-style-type: none"> Deepen the understanding of policies and laws: Study the trends of regulations in different countries and local governments, understand the relevant green incentives and subsidies, conduct business layout in advance, and flexibly adjust the operation strategy Actively participate in industry-related policy making: Cooperate with governmental organizations to deeply participate in the discussion and formulation process of industry-related regulations and policies Sort out carbon assets: Systematically sort out our carbon assets, explore the collaboration between the electricity market and the carbon market, and tap into carbon market opportunities. Understand the regulatory requirements of different countries and the regulatory details of key markets, select key products, and promote product carbon footprint management in an orderly manner
	Opportunities	<ul style="list-style-type: none"> Green financing: Investors and financial institutions are more inclined to invest in green and clean energy projects, and governments may enact green incentive and subsidy policies 	
Technology	Risks	<ul style="list-style-type: none"> Green technology transformation: With the development of low-carbon and green technology, we need to gradually increase our R&D and investment in clean technology to improve energy efficiency and reduce pollution to meet environmental requirements 	<ul style="list-style-type: none"> Invest in green technologies: Actively invest in and apply low-carbon technologies and clean energy, such as solar energy and BIPV R&D applications Increase R&D investments: Increase R&D investment, explore new environmental protection technologies and management methods, and pay attention to cutting-edge green technologies Enhance green cooperation: Actively seek technology partners or suppliers to jointly develop green solutions
	Opportunities	<ul style="list-style-type: none"> Technological innovation and efficiency improvement: Green technology transformation can drive our technological innovation, improve energy efficiency, recycle resources, and reduce pollutant emissions, thus creating a virtuous cycle 	
Market	Risks	<ul style="list-style-type: none"> Consumers are more inclined to buy products with recycled plastic and better end-of-life management. We need to invest more in R&D of green and low-carbon products to meet the market demand Electronic waste full-lifecycle management requirements are becoming more stringent. To a certain extent, we need to increase the cost investment in the recycling business 	<ul style="list-style-type: none"> Improve business diversification: Explore and develop green products, continue to promote the R&D and production of labelers and A3 printers with low-carbon design, and obtain relevant green certifications Enhance market adaptability: The strategy departments need to adjust business strategies to respond to changes in demand and market volatility through market research and data analysis Increase customer communication: Conduct research and communicate with key customers on their green and sustainable development preferences
	Opportunities	<ul style="list-style-type: none"> Green business opportunities: With the low-carbon transition, new business opportunities may arise, such as the development and application of renewable energy such as rooftop photovoltaics in parks 	
Reputation	Risks	<ul style="list-style-type: none"> Public expectations: Stakeholders such as domestic and international consumers have increasing expectations for corporate environmental responsibility. Failure to respond effectively to climate change or to take appropriate environmental protection measures could damage its brand and reputation and affect its business relationships and market position 	<ul style="list-style-type: none"> Take more social responsibilities: Improve corporate image and brand value by actively carrying out and participating in social and ecological environmental protection activities Communicate efficiently and transparently: Establish an effective communication mechanism, strengthen information disclosure, and timely convey to the public and stakeholders the enterprise's environmental protection actions and effectiveness
	Opportunities	<ul style="list-style-type: none"> Brand image improvement: Actively addressing climate change and implementing sustainable development strategies can enhance our reputation 	

8.6.3.3 Emergency response plans and drills

We continue to improve our emergency response plans and conduct regular emergency rescue drills, including predicting risk points and checking and preparing materials before typhoons, as well as work and production resumption inspections after typhoons, in order to minimize the impact of extreme weather on production and operations.

We are headquartered in Zhuhai, Guangdong Province, where extreme weather such as heavy rainfall, typhoons, and hot weather is common in the summer, with wind speeds reaching up to Force 14 (45 meters per second). In order to cope with the extreme weather during the typhoon season, we prepare emergency supplies in accordance with the requirements of the emergency response plans for unexpected environmental incidents and reinforce key infrastructure, such as the windows and doors of factories and warehouses, thus minimizing the potential damage to production facilities caused by extreme weather. Doing so ensures that we are able to respond swiftly to the onset of typhoons and to take the necessary protective measures.

In 2023, we issued early warning information in advance of the typhoon and organized safety inspections of each production site by the person in charge of safety to implement typhoon defense. At the same time, we arranged for our employees to return home by bus. During the Reporting Period, the typhoon did not cause any significant damage to us, and there were no casualties. During high temperatures in Zhuhai, we strictly enforce the regulation to cease work when temperatures exceed 40 degrees Celsius. We also provide employees with heat protection equipment and medication, and no incidents of heatstroke occurred among employees this year. Additionally, we organize activities such as hiking to enhance employees' environmental awareness and encourage active participation in ecological protection.



8.6.4 Indicators and objectives

Objectives	Annual progress
<p>We focus on comprehensive product lifecycle management, from design, production, transportation, to use and final disposal, aiming to minimize the environmental impact of end-of-life products.</p> <p>We encourage suppliers to adopt environmental measures, including the use of renewable resources, waste reduction, and improved logistics efficiency. By monitoring and mitigating our supply chain's environmental impact, we aim to promote the enhancement of suppliers' environmental management standards.</p> <p>We strive to achieve net-zero carbon emissions from our operations by improving energy efficiency, using cleaner energy sources, and optimizing production processes</p> <p>We will invest more than CNY500 million in the next five years, focusing on clean technology R&D, upgrading of new fixture equipment, technology upgrades, and low-power chip research</p>	<p>Through the adoption of clean technologies and process optimization, along with the continued implementation of recycling and reuse initiatives, we have reduced resource consumption and waste generation. This has led to a significant decrease in the environmental footprint across the product lifecycle.</p> <p>In 2023, we aggressively pursued our photovoltaic power generation project to increase the proportion of clean energy used, such as solar and wind. The air-conditioning compressor system was optimized and upgraded, reducing the demand for purchased electricity by 830,000 kWh</p> <p>By optimizing the hardware design of our printers through technological innovations, we have improved energy efficiency</p> <p>We have continued to increase R&D investment in clean technology, committed to upgrading our technology and equipment.</p>

9 Appendix

9.1 Appendix I: Key Performance Indexes (KPIs) of 2023 ESG Report

Environmental Performance⁸

ESG Indicator Category		Unit	Data in 2023
Emissions ⁹	Direct greenhouse gas (GHG) emissions (Scope 1)	tCO ₂ e	269.46
	Indirect greenhouse gas (GHG) emissions (Scope 2)	tCO ₂ e	25,716.80
	Total greenhouse gas (GHG) emissions	tCO ₂ e	25,986.26
	Greenhouse gas (GHG) emission intensity	tCO ₂ e/CNY10,000 of revenue	0.0108
	COD	ton	11.50
	Suspended solids	ton	0.74
	Petroleum	ton	0.04
	Animal and vegetable oil	ton	0.03
	Anilines	ton	0.02
	Five-day biochemical oxygen demand (BOD ₅)	ton	2.92
	Particulate matter	ton	2.19
	Total VOCs	ton	1.98
	Total water consumption	ton	1,039,532.69
	Total industrial wastewater	ton	186,760.00
Material	Usage of packaging materials	ton	23,749.31
	Usage of sustainable packaging materials	ton	18,154.26
	Total hazardous waste disposal	ton	259.49
	Total general waste disposal ¹⁰	ton	1,765.59
	Office waste emissions	ton	595.44
Energy ¹¹	Production waste (unrecyclable) emissions	ton	1,170.15
	Outsourced electricity usage	10,000 kWh	4,509.35
	photovoltaic power generation equipment (non-utility)	10,000 kWh	215.64
	Gasoline usage	Liter	75,609.14
	Diesel usage	Liter	37,395.75
	Total overall energy consumption	Ton of standard coal equivalent	5,935.34
	Direct energy consumption	Ton of standard coal equivalent	393.35
Indirect energy consumption	Ton of standard coal equivalent	5,541.99	
Comprehensive energy consumption intensity	Ton of standard coal/CNY10,000 of revenue	0.0025	

⁸Environmental data were collected from January 1, 2023 to December 31, 2023.

The scope of the collection includes:

- Energy use in the office area and production area of our headquarters and subsidiaries;
- Energy use of official vehicles and transportation vehicles of our headquarters and subsidiaries;

⁹The disclosed values of greenhouse gas emissions include consumption of gasoline, diesel, pipeline gas, natural gas and outsourced electricity. Scope 1 emission factors are calculated with reference to the Guidelines for Accounting Methods and Reporting of Greenhouse Gas Emissions by Public Construction Operators (Enterprises) (Trial) issued by the General Office of the National Development and Reform Commission of China; Scope 2 greenhouse gas emissions data are derived from outsourced electricity, and greenhouse gas emission factors of the power grid in Chinese Mainland refer to the Notice on the Management of Greenhouse Gas Emission Reporting of Enterprises in the Power Generation Industry from 2023 to 2025.

¹⁰Our non-hazardous waste consists of office waste generated in the office area and production waste from each subsidiary.

¹¹The energy consumption values include the consumption of gasoline, diesel, natural gas and outsourced electricity, the relevant factors of which are calculated with reference to GB 2589-2020 General Principles for Calculation of the Comprehensive Energy Consumption of China.

Social Performance

ESG Indicator Category		Unit	Data in 2023
Employment ¹²	Number of employees by gender, educational background, age group and geographical region		
	Total number of employees	Person	21,997
	Number of male employees	%	58
	Number of female employees	%	42
	Junior college or below	%	61.0
	Undergraduate	%	31.8
	Graduate or above	%	7.2
	Employees aged 29 and below	%	39.77
	Employees aged 30-49	%	48.85
	Employees aged 50 or above	%	11.38
	Chinese mainland	%	58.32
	Hong Kong, Macao and Taiwan	%	0.02
	Overseas	%	41.66
	Employee turnover	%	10.20
Occupational Health and Safety	Number of employee deaths related to work in the past three years (2021-2023)	Person	0
	Number of working days lost due to work-related injury during the year	Day	0
	Safety incidents	Case	0
	Training 35,638 hours of production safety and occupational health	Hour	35,638
	Cumulative trainees of production safety and occupational health training during the year	Person-time	12,224
Training and Education	Total number of trained employees by gender and their training hours		
	Total number of trained employees	Person	8,206
	Trained male employees	Person	4,817
	Trained female employees	Person	3,389
	Total training hours of employees	Hour	165,533.5
	Average training hours of male employees	Hour	8
	Average training hours of female employees	Hour	8
Supplier Management	Total number of suppliers managed in the year	Supplier	1,287
	Number of audited suppliers	Supplier	705
Customer Service	Received cases of product and service complaints	Case	3,264
	Cases of handled product and service complaints	Case	3,151
Anti-corruption	Number of concluded corruption lawsuits brought against the issuers or employees	Case	0

Economic Performance

ESG Indicator Category		Unit	Data in 2023
Training and Education	Total amount invested in employee training	CNY10,000	384
Local Community	Investment in social assistance	CNY10,000	133
Production Safety	Total amount invested in production safety	CNY10,000	2,019.55

¹²Due to local laws and regulations, some overseas subsidiaries could not provide age and gender data of the employees.

9.2 Appendix II: Content Index of Global Reporting Initiative (GRI) Standards

Instructions for use	We report the information referenced in this GRI Content Index by reference to GRI standards from January 1, 2023 to December 31, 2023.
GRI 1	GRI 1: Basis 2021

No.	Indicator	Disclosure Item	Sections
1	GRI 2: General Disclosures	2-1 Organizational details	About the Report
2		2-2 Entities included in the organization's sustainable development reporting	About the Report
3		2-3 Reporting period, frequency and contact point	About the Report
4		2-4 Restatements of information	About Ninestar
5		2-5 External assurance	/
6		2-6 Activities, value chain and other business relationships	About Ninestar
7		2-7 Employees	Employees' Rights, interests, diversity and Equity
8		2-8 Workers who are not employees	Employees' Rights, Interests, Diversity and Equity
9		2-9 Governance structure and composition	Corporate Governance
10		2-10 Nomination and selection of the highest governance body	Corporate Governance
11		2-11 Chair of the highest governance body	Corporate Governance
12		2-12 Role of the highest governance body in overseeing the management of impacts	Corporate Governance
13		2-13 Delegation of responsibility for managing impacts	Corporate Governance
14		2-14 Role of the highest governance body in sustainable development reporting	Corporate Governance
15		2-15 Conflict of interest	N/A
16		2-16 Communication of critical concerns	Corporate Governance
17		2-17 Collective knowledge of the highest governance body	/
18		2-18 Evaluation of the performance of the highest governance body	/
19		2-19 Remuneration policies	Employees' Rights, Interests, Diversity and Equity
20		2-20 Process to determine remuneration	Employees' Rights, Interests, Diversity and Equity
21		2-21 Annual total compensation ratio	/
22		2-22 Statement on sustainable development strategy	Implementing ESG Management
23		2-23 Policy commitments	Implementing ESG Management
24		2-24 Embedding policy commitments	Implementing ESG Management
25		2-25 Processes to remediate negative impacts	/
26		2-26 Mechanisms for seeking advice and raising concerns	About Ninestar
27		2-27 Compliance with laws and regulations	Corporate Governance
28		2-28 Membership associations	/
29		2-29 Approach to stakeholder engagement	Implementing ESG Management
30		2-30 Collective bargaining agreements	/

No.	Indicator	Disclosure Item	Sections
31	GRI 3: Material Topics	3-1 Process to determine material topics	Implementing ESG Management
32		3-2 List of material topics	Implementing ESG Management
33		3-3 Management of material topics	Implementing ESG Management
34	GRI 201: Economic Performance	201-1 Direct economic value generated and distributed	/
35		201-2 Financial implications and other risks and opportunities due to climate change	/
36		201-3 Defined benefit plan obligations and other retirement plans	/
37		201-4 Financial assistance received from government	/
38	GRI 202: Market Presence	202-1 Ratios of standard entry level wage by gender compared to local minimum wage	/
39		202-2 Proportion of senior management hired from the local community	/
40	GRI 203: Indirect Economic Impact	203-1 Infrastructure investments and services supported	Community Philanthropy
41		203-2 Significant indirect economic impacts	/
42	GRI 204: Procurement Practices	204-1 Proportion of spending on local suppliers	Responsible Supply Chain Management
43	GRI 205: Anti-corruption	205-1 Operations assessed for risks related to corruption	Business Ethics and Anti-corruption
44		205-2 Communication and training about anti-corruption policies and procedures	Business Ethics and Anti-corruption
45		205-3 Confirmed incidents of corruption and actions taken	Business Ethics and Anti-corruption
46	GRI 206: Anti-competitive Behavior	206-1 Legal actions for anti-competitive behavior, antitrust, and monopoly practices	Business Ethics and Anti-corruption
47	GRI 207: Tax	207-1 Approach to tax	/
48		207-2 Tax governance, control, and risk management	/
49		207-3 Stakeholder engagement and management of concerns related to tax	/
50		207-4 Country-by-country reporting	/
51	GRI 301: Materials	301-1 Materials used by weight or volume	Green Products Key Performance Indexes (KPSs) of 2023 ESG Report
52		301-2 Recycled input materials used	Green Products
53		301-3 Reclaimed products and their packaging materials	Green Products
54	GRI 302: Energy	302-1 Energy consumption within the organization	Energy Management Key Performance Indexes (KPSs) of 2023 ESG Report
55		302-2 Energy consumption outside of the organization	Energy Management Key Performance Indexes (KPSs) of 2023 ESG Report
56		302-3 Energy intensity	Energy Management Key Performance Indexes (KPSs) of 2023 ESG Report
57		302-4 Reduction of energy consumption	Energy Management
58		302-5 Reductions in energy requirements of products and services	Energy Management
59	GRI 303: Water and Effluents	303-1 Interactions with water as a shared resource	Water Resources Management
60		303-2 Management of water discharge-related impacts	Water Resources Management
61		303-3 Water withdrawal	Water Resources Management

No.	Indicator	Disclosure Item	Sections
62	GRI 303: Water and Effluents	303-4 Water discharge	Water Resources Management
63		303-5 Water consumption	Water Resources Management Key Performance Indexes (KPSs) of 2023 ESG Report
64	GRI 304: Biodiversity	304-1 Operational sites owned, leased, managed in, or adjacent to, protected areas and areas of high biodiversity value outside protected areas	N/A
65		304-2 Significant impacts of activities, products, and services on biodiversity	N/A
66		304-3 Habitats protected or restored	N/A
67		304-4 IUCN Red List species and national conservation list species with habitats in areas affected by operations	N/A
68	GRI 305: Emissions	305-1 Direct (Scope 1) Greenhouse gas (GHG) emissions	Energy Management Key Performance Indexes (KPSs) of 2023 ESG Report
69		305-2 Energy indirect/Scope 2 Greenhouse gas (GHG) emissions	Energy Management Key Performance Indexes (KPSs) of 2023 ESG Report
70		305-3 Other indirect/Scope 3 Greenhouse gas (GHG) emissions	/
71		305-4 Greenhouse gas (GHG) emissions intensity	Energy Management Key Performance Indexes (KPSs) of 2023 ESG Report
72		305-5 Reduction of Greenhouse gas (GHG) emissions	/
73		305-6 Emissions of ozone-depleting substances (ODS)	/
74		305-7 Nitrogen oxides (NOx), sulfur oxides (SOx), and other significant air emissions	/
75	GRI 306: Effluents and Waste	306-1 Waste generation and significant waste-related impacts	Waste Management
76		306-2 Actions taken to prevent waste generation	Waste Management
77		306-3 Composition of waste generated	Waste Management Key Performance Indexes (KPSs) of 2023 ESG Report
78		306-4 Recovery operations used to divert waste from disposal	Waste Management
79		306-5 Disposal operations	Waste Management
80	GRI 308: Supplier Environmental Assessment	308-1 New suppliers that were screened using environmental criteria	Responsible Supply Chain Management
81		308-2 Negative environmental impacts in the supply chain and actions taken	Responsible Supply Chain Management
82	GRI 401: Employment	401-1 New employee hires and employee turnover	Employees' Rights, Interests, Diversity and Equity Key Performance Indexes (KPSs) of 2023 ESG Report
83		401-2 Benefits provided to full-time employees that are not provided to temporary or part-time employees	Employees' Rights, Interests, Diversity and Equity
84		401-3 Parental leave	Employees' Rights, Interests, Diversity and Equity
85	GRI 402: Labor/Management Relations	402-1 Minimum notice periods regarding operational changes	Employees' Rights, Interests, Diversity and Equity
86	GRI 403: Occupational Health and Safety	403-1 Occupational health and safety management system	Occupational Health and Safety
87		403-2 Hazard identification, risk assessment, and incident investigation	Occupational Health and Safety
88		403-3 Occupational health services	Occupational Health and Safety
89		403-4 Worker participation, consultation, and communication on occupational health and safety	Occupational Health and Safety

No.	Indicator	Disclosure Item	Sections
90	GRI 403: Occupational Health and Safety	403-5 Worker training on occupational health and safety	Occupational Health and Safety
91		403-6 Promotion of worker health	Occupational Health and Safety
92		403-7 Prevention and mitigation of occupational health and safety impacts directly linked by business relationships	Occupational Health and Safety
93		403-8 Workers covered by an occupational health and safety management system	Occupational Health and Safety
94		403-9 Work-related injuries	Occupational Health and Safety
95		403-10 Work-related ill health	Occupational Health and Safety
96	GRI 404: Training and Education	404-1 Average hours of training per year per employee	Human Capital Development
97		404-2 Programs for upgrading employee skills and transition assistance programs	Human Capital Development
98		404-3 Percentage of employees receiving regular performance and career development reviews	Human Capital Development
99	GRI 405: Diversity and Equal Opportunities	405-1 Diversity of governance bodies and employees	Employees' Rights, Interests, Diversity and Equity
100		405-2 Ratio of basic salary and remuneration of women to men	/
101	GRI 406: Non-discrimination	406-1 Incidents of discrimination and corrective actions taken	Employees' Rights, Interests, Diversity and Equity
102	GRI 407: Freedom of Association and Collective Bargaining	407-1 Operations and suppliers in which the right to freedom of association and right of collective bargaining may be at risk	Employees' Rights, Interests, Diversity and Equity
103	GRI 408: Child Labor	408-1 Operations and suppliers at significant risk for incidents of child labor	Employees' Rights, Interests, Diversity and Equity
104	GRI 409: Forced or Compulsory Labor	409-1 Operations and suppliers at significant risk for incidents of forced or compulsory labor	Employees' Rights, Interests, Diversity and Equity
105	GRI 410: Security Practices	410-1 Security personnel trained in human rights policies or procedures	/
106	GRI 411: Rights of Indigenous Peoples	411-1 Incidents of violations involving rights of indigenous peoples	N/A
107	GRI 413: Local Communities	413-1 Operations with local community engagement, impact assessments, and development programs	Community Philanthropy
108		413-2 Operations with significant actual and potential negative impacts on local communities	/
109	GRI 414: Supplier Social Assessment	414-1 New suppliers that were screened using social criteria	Responsible Supply Chain Management
110		414-2 Negative social impacts in the supply chain and actions taken	Responsible Supply Chain Management
111	GRI 415: Public Policy	415-1 Political contributions	N/A
112	GRI 416: Customer Health and Safety	416-1 Assessment of the health and safety impacts of product and service categories	Product Responsibility
113		416-2 Incidents of non-compliance concerning the health and safety impacts of products and services	Product Responsibility
114	GRI 417: Marketing and Labeling	417-1 Requirements for product and service information and labeling	Product Responsibility
115		417-2 Incidents of non-compliance concerning product and service information and labeling	Product Responsibility
116		417-3 Incidents of non-compliance concerning marketing communications	Product Responsibility
117	GRI 418: Customer Privacy	418-1 Substantiated complaints concerning breaches of customer privacy and losses of customer data	Information Security and Privacy Protection

9.3 Appendix III: Feedback Form

Valued readers:

Thank you for reading the Report. This is our Environmental, Social and Governance (ESG) Report 2023. We sincerely hope that you could evaluate the Report and provide valuable comments to help us make continuous improvement.

Should you have any comments or suggestions on our ESG Report, please feel free to email us by info@ggimage.com.

Feedback Form of 2023 ESG Report of Ninestar Corporation

Name:	Tel.:
Work unit:	Email:
Position:	

Your comments on the Report: (Please tick "√" in the corresponding box)

1. Do you think the Report has highlighted the important information about us in terms of environment, society and governance?

Great Good Average

2. Do you think the information and indicators disclosed in the Report are clear, accurate and complete?

Great Good Average

3. Do you think the content arrangement and style design of the Report are convenient for reading?

Great Good Average

Which part of the Report are you most interested in?

What information you think you need to know is not reflected in the Report?

Do you have any other suggestions for us to issue the ESG Report?

NineStar